

This manual should be considered a permanent part of the vehicle and should remain with the vehicle when it is resold.

This publication includes the latest production information available before printing. Honda Motor Co., Ltd. reserves the right to make changes at any time without notice and without incurring any obligation.

No part of this publication may be reproduced without written permission.

The vehicle pictured in this owner's manual may not match your actual vehicle.

India

For any query or assistance, please call Customer care number: 1800 103 3434 (Toll free)

Welcome

Congratulations on your purchase of a new Honda vehicle. Your selection of a Honda makes you part of a worldwide family of satisfied customers who appreciate Honda's reputation for building quality into every product.

To ensure your safety and riding pleasure:

- Read this owner's manual carefully.
- Follow all recommendations and procedures contained in this manual.
- Pay close attention to safety messages contained in this manual and on the vehicle.

- The following codes in this manual indicate each country.
- The illustrations here in are based on the XL750 ED type.

Country Code

Code	Country
------	---------

XL750

ED, III ED	European direct sales, Turkey, Ukraine, India, Singapore, South Africa, North Macedonia, Monte Negro
------------	--

II ED, IV ED	European direct sales, Turkey
--------------	-------------------------------

*The specifications may vary with each locale.

A Few Words About Safety

Your safety, and the safety of others, is very important. Operating this vehicle safely is an important responsibility.

To help you make informed decisions about safety, we have provided operating procedures and other information on safety labels and in this manual. This information alerts you to potential hazards that could hurt you or others.

Of course, it is not practical or possible to warn you about all hazards associated with operating or maintaining a vehicle. You must use your own good judgement.

You will find important safety information in a variety of forms, including:

- Safety labels on the vehicle
- Safety Messages preceded by a safety alert symbol  and one of three signal words: DANGER, WARNING, or CAUTION.

These signal words mean:

DANGER

You **WILL** be **KILLED** or **SERIOUSLY HURT** if you don't follow instructions.

WARNING

You **CAN** be **KILLED** or **SERIOUSLY HURT** if you don't follow instructions.

CAUTION

You **CAN** be **HURT** if you don't follow instructions.

Other important information is provided under the following titles:

NOTICE Information to help you avoid damage to your vehicle, other property, or the environment.

Contents

Vehicle Safety	P. 2	■
Operation Guide	P. 22	■
Maintenance	P. 99	■
Troubleshooting	P. 138	■
Information	P. 152	■
Specifications	P. 168	■

Vehicle Safety

This section contains important information for safe riding of your vehicle.
Please read this section carefully.

Safety Guidelines	P. 3
Image Labels	P. 7
Safety Precautions	P. 12
Riding Precautions	P. 14
Accessories & Modifications	P. 19
Off-Road Safety	P. 20
Loading	P. 21

Safety Guidelines

Safety Guidelines

Follow these guidelines to enhance your safety:

- Perform all routine and regular inspections specified in this manual.
- Stop the engine and keep sparks and flames away before filling the fuel tank.
- Do not run the engine in enclosed or partly enclosed areas. Carbon monoxide in exhaust gases is toxic and can kill you.

Always Wear a Helmet

It's a proven fact: helmets and protective apparel significantly reduce the number and severity of head and other injuries. So always wear an approved helmet and protective apparel. ➤ P. 12

Before Riding

Make sure that you are physically fit, mentally focused, and free of alcohol and drugs. Check that you and your passenger are both wearing an approved helmet and protective apparel. Instruct your passenger on holding onto the grab rail or your waist, leaning with you in turns, and keeping their feet on the footpegs, even when the vehicle is stopped.

Take Time to Learn & Practice

Even if you have ridden other vehicles, practice riding in a safe area to become familiar with how this vehicle works and handles, and to become accustomed to the vehicle's size and weight.

Safety Guidelines

Vehicle Safety

Ride Defensively

Always pay attention to other vehicles around you, and do not assume that other drivers see you. Be prepared to stop quickly or perform an evasive maneuver.

Make Yourself Easy to See

Make yourself more visible, especially at night, by wearing bright reflective clothing, positioning yourself so other drivers can see you, signaling before turning or changing lanes, and using your horn when necessary.

Be Alert for Off-road Hazards

The terrain can be present a variety of challenges when you ride off-road. Continually "read" the terrain for unexpected turns, drop-offs, rocks, ruts and other hazards. Always keep your speed low enough to allow time to see and react to hazards.

Ride within Your Limits

Never ride beyond your personal abilities or faster than conditions warrant. Fatigue and inattention can impair your ability to use good judgement and ride safely.

Don't Drink or Use Drugs and Ride

Alcohol or drugs and riding don't mix. Even one alcoholic drink can reduce your ability to respond to changing conditions, and your reaction time gets worse with every additional drink. The same is true for drug use. Don't drink or use and ride, and don't let your friends do it either.

Safety Guidelines

Keep Your Honda in Safe Condition

It's important to keep your vehicle properly maintained and in safe riding condition. Having a breakdown can be difficult, especially if you are stranded off-road far from your base. Inspect your vehicle before every ride and perform all recommended maintenance. Never exceed load limits (▶ P. 21), and do not modify your vehicle or install accessories that would make your vehicle unsafe (▶ P. 19).

If You are Involved in a Crash

Personal safety is your first priority. If you or anyone else has been injured, take time to assess the severity of the injuries and whether it is safe to continue riding. Call for emergency assistance if needed. Also follow applicable laws and regulations if another person or vehicle is involved in the crash.

If you decide to continue riding, first turn the ignition switch to the **O** (Off) position, and evaluate the condition of your vehicle. Inspect for fluid leaks, check the tightness of critical nuts and bolts, and check the handlebar, control levers, brakes, and wheels. Ride slowly and cautiously.

Your vehicle may have suffered damage that is not immediately apparent. Have your vehicle thoroughly checked at a qualified service facility as soon as possible.

Safety Guidelines

Vehicle Safety

Carbon Monoxide Hazard

Exhaust contains poisonous carbon monoxide, a colourless, odorless gas. Breathing carbon monoxide can cause loss of consciousness and may lead to death.

If you run the engine in a confined or even partly enclosed area, the air you breathe could contain a dangerous amount of carbon monoxide.

Never run your vehicle inside a garage or other enclosure.

WARNING

Running the engine of your vehicle while in an enclosed or even partially enclosed area can cause a rapid build-up of toxic carbon monoxide gas.

Breathing this colourless, odorless gas can quickly cause unconsciousness and lead to death.

Only run your vehicle's engine when it is located in a well ventilated area outdoors.

Image Labels

The following pages describe the label meanings. Some labels warn you of potential hazards that could cause serious injury. Others provide important safety information. Read this information carefully and don't remove the labels.

If a label comes off or becomes hard to read, contact your dealer for a replacement.

There is a specific symbol on each label. The meanings of each symbol and label are as follows.



Read instructions contained in Owner's Manual carefully.



Read instructions contained in Shop Manual carefully. In the interest of safety, take the vehicle to be serviced only by your dealer.



DANGER (with RED background)

You WILL be KILLED or SERIOUSLY HURT if you don't follow instructions.

WARNING (with ORANGE background)

You CAN be KILLED or SERIOUSLY HURT if you don't follow instructions.

CAUTION (with YELLOW background)

You CAN be HURT if you don't follow instructions.

Image Labels



BATTERY LABEL DANGER

- Keep flame and spark away from the battery. Battery produce explosive gas that can cause explosion.
- Wear the eye protection and rubber gloves when handling the battery, or you can get burned or lose your eyesight by the battery electrolyte.
- Do not allow children and other people to touch a battery unless they understand proper handling and hazards of the battery very well.
- Handle the battery electrolyte with extreme care as it contains dilute sulfuric acid. Contact with your skin or eyes can burn you or cause loss of your eyesight.
- Read this manual carefully and understand it before handling the battery. Neglect of the instructions can cause personal injury and damage to the vehicle.
- Do not use a battery with the electrolyte at or below the lower level mark. It can explode causing serious injury.

Image Labels



RADIATOR CAP LABEL DANGER

NEVER OPEN WHEN HOT.

Hot coolant will scald you.

Relief pressure valve begins to open at **1.1 kgf/cm²**.

ACCESSORIES AND LOADING WARNING LABEL WARNING

ACCESSORIES AND LOADING

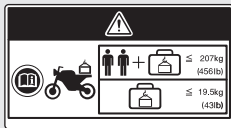

- The safety stability and handling of this vehicle may be affected by the addition of accessories and luggage.
- Read carefully the instructions contained in user's manual and installation guide before installing any accessory.
- The total weight of accessories and luggage added to rider's and passenger's weight should not exceed **207 kg (456 lb)**, which is the maximum weight capacity.
- The luggage weight must not exceed **19.5 kg (43 lb)** under any circumstances.
- The fitting of large fork-mounted or large handlebar mounted fairing is not recommended.

Vehicle Safety

Image Labels

Vehicle Safety



REAR CUSHION LABEL

GAS FILLED

Do not open. Do not heat.

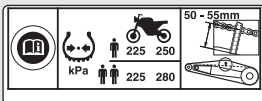

TYRE INFORMATION & DRIVE CHAIN LABEL

Cold tyre pressure:

[Driver only]

Front **225 kPa (2.25 kgf/cm², 33 psi)**

Rear **250 kPa (2.50 kgf/cm², 36 psi)**

[Driver and passenger]

Front **225 kPa (2.25 kgf/cm², 33 psi)**

Rear **280 kPa (2.80 kgf/cm², 41 psi)**

Keep chain adjusted and lubricated.

Freeplay **50 - 55 mm (2.0 - 2.2 in)**

Image Labels



SAFETY REMINDER LABEL

For your protection, always wear helmet, protective apparel.

FUEL LABEL

Unleaded petrol only
ETHANOL up to 10 % by volume



CARGO LIMIT LABEL

Do not exceed **8.0 kg (17.6 lb)**.

Vehicle Safety

Safety Precautions

Safety Precautions

- Ride cautiously and keep your hands on the handlebar and feet on the footpegs.
- Instruct your passenger to keep their hands on the grab rail or your waist and their feet on the footpegs while riding.
- Always consider the safety of your passenger, as well as other drivers and riders.

Protective Apparel

Make sure that you and any passenger are wearing an approved helmet, eye protection, and high-visibility protective clothing. Avoid wearing loose clothes that could get caught on any part of the vehicle. Ride defensively in response to weather and road conditions.

India

Be sure to avoid loose clothes that could get caught on any part of your vehicle.

Helmet

Safety-standard certified, high-visibility, correct size for your head

- Must fit comfortably but securely, with the chin strap fastened
- Face shield with unobstructed field of vision or other approved eye protection

⚠ WARNING

Not wearing a helmet increases the chance of serious injury or death in a crash.

Make sure that you and any passenger always wear an approved helmet and protective apparel.

Safety Precautions

■ Gloves

Full-finger leather gloves with high abrasion resistance

■ Boots or Riding Shoes

Sturdy boots with non-slip soles and ankle protection

■ Jacket and Trousers

Protective, highly visible, long-sleeved jacket and durable trousers for riding (or a protective suit)

■ Additional Off-road Gear

On-road apparel may also be suitable for casual off-road riding. But if you plan on any serious off-road riding you will need more serious off-road gear. In addition to your helmet and eye protection, we recommend off-road motorcycle boots and gloves, riding pants with knee and hip pads, a jersey with elbow pads, and a chest/shoulder protector.

Riding Precautions

Riding Precautions

Running-in Period

During the first 500 km (300 miles) of running, follow these guidelines to ensure your vehicle's future reliability and performance.

- Avoid full-throttle starts and rapid acceleration.
- Avoid hard braking and rapid down-shifts.
- Ride conservatively.

Brakes

Observe the following guidelines:

- Avoid excessively hard braking and downshifting.
 - ▶ Sudden braking can reduce the vehicle's stability.
 - ▶ Where possible, reduce speed before turning; otherwise you risk sliding out.
- Exercise caution on low traction surfaces.
 - ▶ The tyres slip more easily on such surfaces and braking distances are longer.
- Avoid continuous braking.
 - ▶ Repeated braking, such as when descending long, steep slopes can seriously overheat the brakes, reducing their effectiveness. Use engine braking with intermittent use of the brakes to reduce speed.
- For full braking effectiveness, operate both the front and rear brakes together.

Riding Precautions

■ Anti-lock Brake System (ABS)

This model is equipped with an Anti-lock Brake System (ABS) designed to help prevent the brakes from locking up during hard braking.

- ABS does not reduce braking distance. In certain circumstances, ABS may result in a longer stopping distance.
- ABS does not function at speeds below 10 km/h (6 mph).
- The brake lever and pedal may recoil slightly when applying the brakes. This is normal.
- Always use the recommended front/rear tyres and sprockets to ensure correct ABS operation.

■ Engine Braking

Engine braking helps slow your vehicle down when you release the throttle. For further slowing action, downshift to a lower gear. Use engine braking with intermittent use of the brakes to reduce speed when descending long, steep slopes.

■ Wet or Rainy Conditions

Road surfaces are slippery when wet, and wet brakes further reduce braking efficiency. Exercise extra caution when braking in wet conditions.

If the brakes get wet, apply the brakes while riding at low speed to help them dry.

Riding Precautions

Parking

- Park on a firm, level surface.
- If you must park on a slight incline or loose surface, park so that the vehicle cannot move or fall over.
- Make sure that high-temperature parts cannot come into contact with flammable materials.
- Do not touch the engine, muffler, brakes and other high-temperature parts until they cool down.
- To reduce the likelihood of theft, always lock the handlebar and remove the key when leaving the vehicle unattended. Use of an anti-theft device is also recommended.

Parking with the Side Stand

1. Stop the engine.
2. Push the side stand down.
3. Slowly lean the vehicle to the left until its weight rests on the side stand.
4. Turn the handlebar fully to the left.
 - ▶ Turning the handlebar to the right reduces stability and may cause the vehicle to fall.
5. Turn the ignition switch to the  (Lock) position and remove the key. ➡ P. 76

Riding Precautions

Refuelling and Fuel Guidelines

Follow these guidelines to protect the engine, fuel system and catalytic converter:

- Use only unleaded petrol.
- Use the recommended octane number.
Using lower octane petrol will result in decreased engine performance.
- Do not use fuels containing a high concentration of alcohol.  P. 166
- Do not use stale or contaminated petrol or an oil/petrol mixture.
- Avoid getting dirt or water in the fuel tank.

Riding Precautions

Vehicle Safety

Honda Selectable Torque Control

When the Honda Selectable Torque Control detects rear wheel spin during acceleration, the system will limit the amount of torque applied to the rear wheel based on the Torque Control level selected.

Additionally, the system will limit torque during a wheelie while accelerating based on the Torque Control level selected.

Torque Control will allow some wheel spin during acceleration at the lower Torque Control setting levels. Select a level that is appropriate for your skill and riding conditions.

Torque Control does not work during deceleration and will not prevent the rear wheel from skidding due to engine braking. Do not close the throttle suddenly, especially when riding on slippery surfaces.

Torque Control may not compensate for rough road conditions or rapid throttle operation. Always consider road and weather conditions, as well as your skills and condition, when applying throttle.

If your vehicle gets stuck in mud, snow, or sand, it may be easier to free it by turning off the Torque Control temporarily. Temporarily turning off Torque Control also may help you maintain control and balance when riding on off-road terrain.

Always use the recommended tyres and sprockets to ensure correct Torque Control operation.

Accessories & Modifications

We strongly advise that you do not add any accessories that were not specifically designed for your vehicle by Honda or make modifications to your vehicle from its original design. Doing so can make it unsafe. Modifying your vehicle may also void your warranty and make your vehicle illegal to operate on public roads. Before deciding to install accessories on your vehicle, be certain the modification is safe and legal.

WARNING

Improper accessories or modifications can cause a crash in which you can be seriously hurt or killed.

Follow all instructions in this owner's manual regarding accessories and modifications.

Do not pull a trailer with, or attach a sidecar to, your vehicle. Your vehicle was not designed for these attachments, and their use can seriously impair your vehicle's handling.

Off-Road Safety

Off-Road Safety

Learn to ride in an uncongested off-road area free of obstacles before venturing onto unfamiliar terrain.

- Always obey local off-road riding laws and regulations.
- Obtain permission to ride on private property. Avoid posted areas and obey “NO Trespassing” signs.
- Ride with a friend on another vehicle so that you can assist each other in case of trouble.
- Familiarity with your vehicle is critically important should a problem occur far from help.
- Never ride beyond your ability and experience or faster than conditions warrant.
- If you are not familiar with the terrain, ride cautiously. Hidden rocks, holes, or ravines could spell disaster.
- A muffler is required in most off-road areas. Don't modify your exhaust system.

Remember that excessive noise bothers everyone and creates a bad image for motorcycling.

Loading

- Carrying extra weight affects your vehicle's handling, braking and stability. Always ride at a safe speed and never exceed 130 km/h (80 mph) for the load you are carrying.
- Avoid carrying an excessive load and keep within specified load limits.

Maximum weight capacity/Maximum luggage weight  P. 168

- Tie all luggage securely, evenly balanced, and close to the centre of the vehicle.
- Do not place objects near the lights or the muffler.

Also follow these guidelines when you ride off-road on rough terrain:

- Do not carry a passenger.
- Keep cargo small and light weight. Make sure it cannot easily be caught on brush or other objects, and that it does not interfere with your ability to shift position to maintain balance and stability.

WARNING

Overloading or improper loading can cause a crash and you can be seriously hurt or killed.

Follow all load limits and other loading guidelines in this manual.

Parts Location

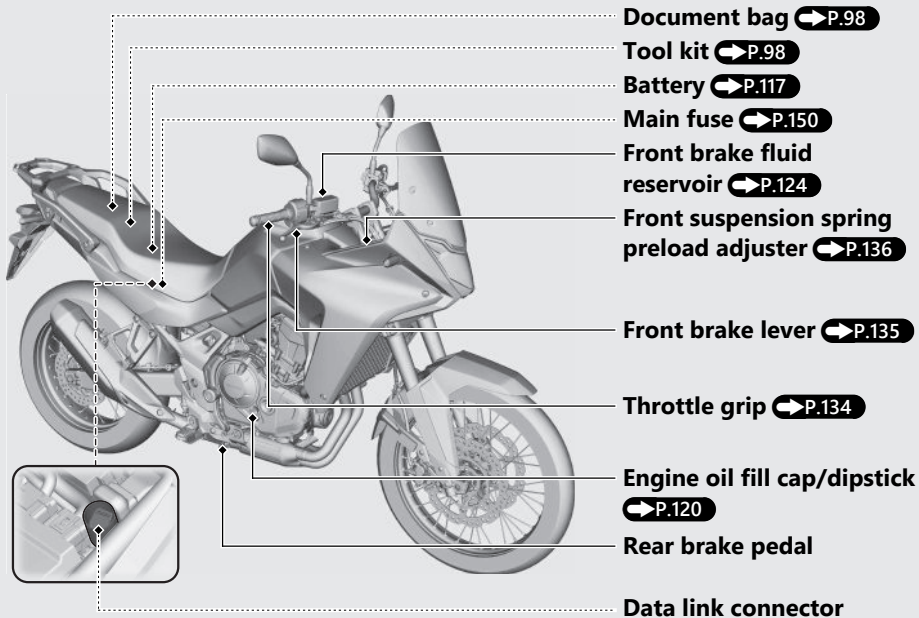

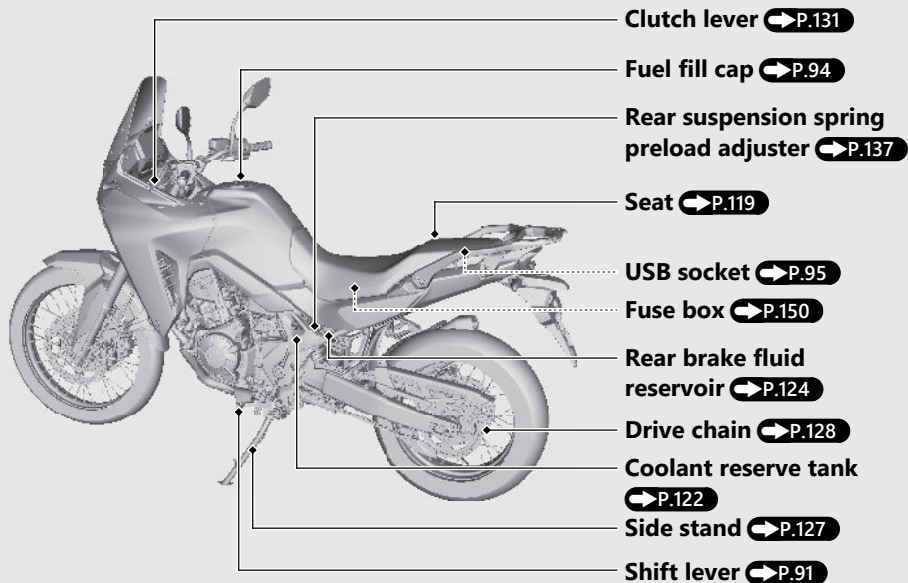

Instruments

You can change the speed and mileage, and fuel mileage meter units. ➡ P.44 ➡ P.57

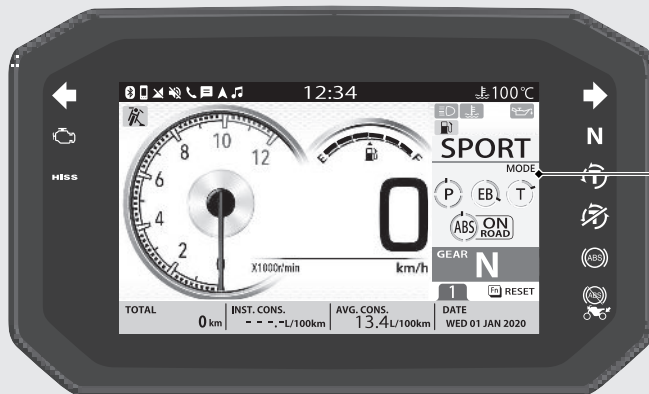

Do not operate the display functions for a long time with the engine stopped. It may result in a low (or dead) battery.

Speedometer/Tachometer/Fuel gauge/Side stand indicator area [P.27](#)

Status bar [P.29](#)

Indicator area [P.30](#)

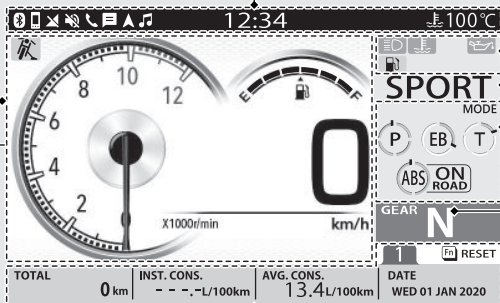

RIDING MODE [P.83](#)

RIDING MODE
PARAMETER [P.83](#) /
Honda Smartphone Voice
Control system area

[P.79](#)

Gear position indicator

[P.30](#)

INFO area [P.31](#) /
Pop-up information [P.66](#)

Instruments (Continued)**Basic Operations**

You can operate and set the various functions of the display using the switches on the left handlebar.

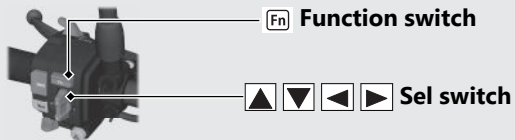

When you switch or set the display, refer to the displayed switch operation guide.

Type of the switch operation guide:

▲ or ^ : Press ▲ on the sel switch

▼ or v : Press ▼ on the sel switch

< : Push the sel switch in the direction of ◀

> : Push the sel switch in the direction of ▶

▲ or ^ : Press and hold ▲ on the sel switch

▼ or v : Press and hold ▼ on the sel switch

◀◀ : Push and hold the sel switch in the direction of ◀

▶▶ : Push and hold the sel switch in the direction of ▶

Speedometer/Tachometer/Fuel gauge/Side stand indicator area

Display type: TYPE 1

Side stand indicator

Comes on when the side stand is down.

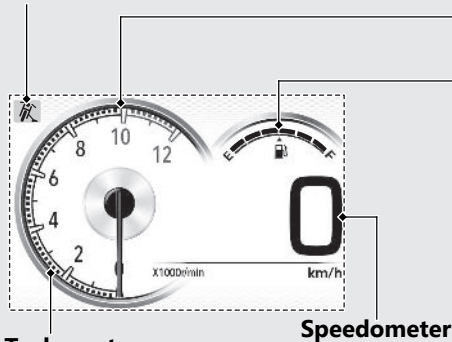
**Tachometer****Speedometer****NOTICE**

Do not operate the engine in the tachometer red zone. Excessive engine speed can adversely affect engine life.

Tachometer red zone

(excessive engine rpm range)

Fuel gauge

Remaining fuel when only 1st (E) segment starts flashing: approximately 3.3 L (0.87 US gal, 0.73 Imp gal)



At the same time, the reserve fuel indicator is comes on.

► **If the fuel gauge indicator flashes in a repeat pattern or turns off:** ➔ P.145

NOTICE

You should refuel when the reading approaches the E (1st) segment. Running out of fuel can cause the engine to misfire, damaging the catalytic converter.

Continued 27

Instruments (Continued)

Speedometer/Tachometer/Fuel gauge/Side stand indicator area has four display types. The display and arrangement of speedometer, tachometer, and fuel gauge change depending on each display type.

To change the display type: ➔P.44 ➔P.52

Display type: TYPE 2

Display type: TYPE 3

Display type: TYPE 4

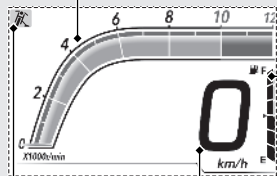
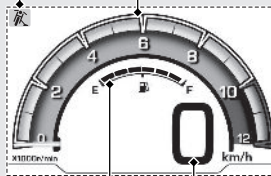
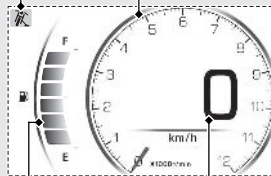
Tachometer**Fuel gauge****Speedometer****Side stand indicator****Side stand indicator****Tachometer****Speedometer****Fuel gauge****Side stand indicator****Tachometer****Fuel gauge****Speedometer**

Status bar



Status icon

Displays the status of the Honda Smartphone Voice Control system. [➔P.79](#)

Clock (12-hour or 24-hour display)

To set the clock: [➔P.44](#) [➔P.56](#)

Coolant temperature gauge

Displays the coolant temperature.

Display range: 35°C to 132°C

- 34 °C or less: "---" is displayed.
- Between 122°C and 131°C:
 - High coolant temperature indicator comes on.
 - Coolant temperature digits flash.
- Above 132 °C:
 - High coolant temperature indicator comes on.
 - "132 °C" flashes.

Instruments *(Continued)*

Indicator area

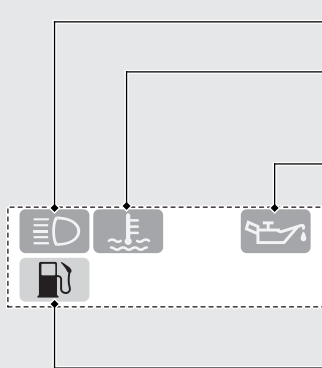

 **High beam indicator**

 **High coolant temperature indicator**

If it comes on while riding:  **P.140**

 **Low oil pressure indicator**

Comes on when the electrical system is turned on.

Goes off when the engine starts.

If it comes on while engine is running:

 **P.141**

 **Low fuel indicator**

Comes on when there is only reserve fuel left in the fuel tank.  **P.27**

Gear position indicator

The gear position is shown in the gear position indicator.

▶ “-” appears when the transmission is not shifted properly.

INFO area

The INFO area displays various vehicle information.

The INFO area has four pages and displays four pieces of information on each page.

Current page number



The information item displayed in the INFO area can be changed arbitrarily.

To change the information: ➡ P.44

➡ P.55

To switch page of the INFO area

To change page of the INFO area, push the sel switch in the direction of ◀ or ▶.

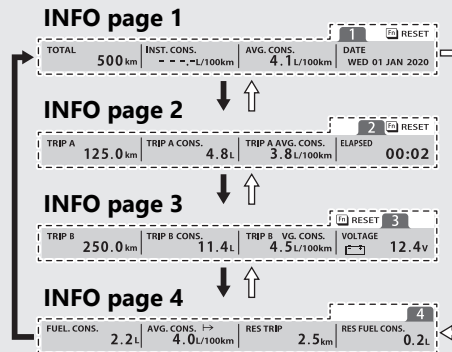

➡ Push the sel switch in the direction of ▶

⇨ Push the sel switch in the direction of ◀

Continued 31

Instruments *(Continued)*

The types of information item that can be displayed in the INFO area are as follows:

TOTAL → P.33

TRIP A → P.33

TRIP A CONS. → P.33

TRIP A AVG. CONS. → P.34

TRIP B → P.34

TRIP B CONS. → P.35

TRIP B AVG. CONS. → P.35

INST. CONS. → P.36

AVG. CONS. → P.36

AVG. SPEED → P.37

ELAPSED → P.37

REV → P.38

GRIP ANGLE → P.38

VOLTAGE → P.38

DATE → P.38

SHIFT POINT → P.39

FUEL CONS. → P.39

AVG. CONS. |→ → P.40

AVG. SPEED |→ → P.40

ELAPSED |→ → P.41

RES TRIP → P.41

RES FUEL CONS. → P.42

Blank → P.42

■ Odometer [TOTAL]

Total distance ridden.

TOTAL
500 km

When "-----" is displayed, go to your dealer for service.

■ Tripmeter A [TRIP A]

Distance ridden since the tripmeter A was reset.

TRIP A
125.0 km

When "----.-" is displayed, go to your dealer for service.

To reset the tripmeter A:  **P.43**

■ Tripmeter A fuel consumption [TRIP A CONS.]

Displays the tripmeter A fuel consumption since the tripmeter A was reset.

Display range: 0.0 to 299.9 L (GAL)

TRIP A CONS.
4.8L

When "---.-" is displayed go to your dealer for service.

Tripmeter A fuel consumption is reset when you reset tripmeter A.

To reset the tripmeter A:  **P.43**

Instruments *(Continued)***■ Tripmeter A average fuel mileage**
[TRIP A AVG. CONS.]

Displays the average fuel mileage since the tripmeter A was reset.

The average fuel mileage will be calculated based on the value on tripmeter A.

Display range: 0.0 to 299.9 L/100 km (km/L, mile/GAL or mile/L)

- When the average fuel mileage is reset: "---.-" is displayed.

TRIP A AVG. CONS.
3.8 L/100km

When "---.-" is displayed except for the above-mentioned cases, go to your dealer for service.

Tripmeter A average fuel mileage is reset when you reset tripmeter A.

To reset the tripmeter A:  **P.43**

■ Tripmeter B [TRIP B]

Distance ridden since the tripmeter B was reset.

TRIP B
250.0 km

When "----.-" is displayed, go to your dealer for service.

To reset the tripmeter B:  **P.43**

Tripmeter B fuel consumption [TRIP B CONS.]

Displays the tripmeter B fuel consumption since the tripmeter B was reset.

Display range: 0.0 to 299.9 L (GAL)

TRIP B CONS.
11.4L

When "---.-" is displayed go to your dealer for service.

Tripmeter B fuel consumption is reset when you reset tripmeter B.

To reset the tripmeter B:  **P.43**

Tripmeter B average fuel mileage [TRIP B AVG. CONS.]

Displays the average fuel mileage since the tripmeter B was reset.

The average fuel mileage will be calculated based on the value on tripmeter B.

Display range: 0.0 to 299.9 L/100 km (km/L, mile/GAL or mile/L)

- When the average fuel mileage is reset: "---.-" is displayed.

TRIP B AVG. CONS.
4.5L/100km

When "---.-" is displayed except for the above-mentioned cases, go to your dealer for service.

Tripmeter B average fuel mileage is reset when you reset tripmeter B.

To reset the tripmeter B:  **P.43**

Instruments *(Continued)*

Current fuel mileage [INST. CONS.]

Displays the current instant fuel mileage.
Display range: 0.0 to 299.9 L/100 km (km/L, mile/GAL or mile/L)

- When your speed is less than 5 km/h (3 mph): "---.-" is displayed.

INST. CONS.

8.0L/100km

When "---.-" is displayed except for the above-mentioned cases, go to your dealer for service.

Average fuel mileage [AVG. CONS.]

Displays the average fuel mileage since the average fuel mileage was reset.

Display range: 0.0 to 299.9 L/100 km (km/L, mile/GAL or mile/L)

- When the average fuel mileage is reset: "---.-" is displayed.

AVG. CONS.

4.1L/100km

When "---.-" is displayed except for the above-mentioned cases, go to your dealer for service.

To reset the average fuel mileage

➡ P.43

■ Average speed [AVG. SPEED]

Displays the average speed since the average speed was reset.

Display range: 0.0 to 299.9 km/h (0 to 186 mph)

- Initial display: "---" is displayed.
- When your vehicle has traveled less than 0.2 km since the engine was started: "---" is displayed.
- When your vehicle operating time is less than 16 seconds since the engine was started: "---" is displayed.

AVG. SPEED
57 km/h

When "---" is displayed except for the above-mentioned cases, go to your dealer for service.

To reset the average speed ➡ P.43

■ Elapsed time [ELAPSED]

Displays the engine operating time since the elapsed time was reset.

Display range: 00:00 to 99:59 (hours:minutes)

- Above 99:59: back to 00:00

ELAPSED
02:30

When "--:--" is displayed, go to your dealer for service.

To reset the elapsed time ➡ P.43

Instruments *(Continued)*

Numerical tachometer display [REV]

Displays the engine revolutions per minutes.

REV
5200 r/min

Throttle grip angle [GRIP ANGLE]

Displays the throttle grip angle during operation.

GRIP ANGLE
30 deg

When "--" is displayed, go to your dealer for service.

Battery voltage [VOLTAGE]

Displays the current voltage.

VOLTAGE
 **13.6** v

Date [DATE]

Displays the date of today.

DATE
WED 01 JAN 2020

To set the date:  **P.44**  **P.56**

SHIFT POINT set value [SHIFT POINT]

Displays the SHIFT POINT set value.

Display range: 5,000 - 10,000 r/min

SHIFT POINT
6500 r/min

To set the SHIFT POINT:  P.44

 P.50

Fuel consumption in this time [FUEL CONS.]

Displays the fuel consumption since the electrical system was turned on.

Display range: 0.0 to 50.0 L (GAL)

- Initial display: "--.-" is displayed.

When the electrical system is turned off, the fuel consumption is reset.

FUEL. CONS.
2.2 L

When "--.-" is displayed except for the above-mentioned cases, go to your dealer for service.

Instruments *(Continued)*

Average fuel mileage in this time [AVG. CONS. ↗]

Displays the average fuel mileage since the electrical system was turned on.

Display range: 0.0 to 299.9 L/100 km (km/L, mile/GAL or mile/L)

- Initial display: "---.-" is displayed.

When the electrical system is turned off, the average fuel mileage is reset.

AVG. CONS.↗
4.3 L/100km

When "---.-" is displayed except for the above-mentioned cases, go to your dealer for service.

Average speed in this time [AVG. SPD ↗]

Displays the average speed since the electrical system was turned on.

Display range: 0 to 299 km/h (0 to 186 mph)

- Initial display: "---" is displayed.
- When your vehicle has traveled less than 0.2 km since the engine was started: "---" is displayed.
- When your vehicle operating time is less than 16 seconds since the engine was started: "---" is displayed.

When the electrical system is turned off, the average speed is reset.

AVG. SPEED↗
95 km/h

When "---" is displayed except for the above-mentioned cases, go to your dealer for service.

Elapsed time in this time [ELAPSED



Displays the engine operating time since the electrical system was turned on.

Display range: 00:00 to 99:59 (hours:minutes)

- Above 99:59: back to 00:00.
- Initial display: "--:--" is displayed.

When the electrical system is turned off, the elapsed time is reset.

ELAPSED →

01:30

When "--:--" is displayed except for the above-mentioned cases, go to your dealer for service.

Reserve tripmeter [RES TRIP]

Distance ridden since the reserve fuel indicator lights.

Display range: 0.0 to 9999.9 km (mile)

- Above 9999.9: back to 0.0.
- When the reserve fuel indicator is off: "----.-" is displayed.

RES TRIP

3.5km

When "----.-" is displayed except for the above-mentioned cases, go to your dealer for service.

Instruments *(Continued)*

Reserve fuel consumption [RES FUEL CONS.]

Displays the fuel consumption since the reserve fuel indicator lights.

Display range: 0.0 to 50.0 L (GAL)

- When the reserve fuel indicator is off:
"---.-" is displayed.

RES FUEL CONS.

0.2L

When "---.-" is displayed except for the above-mentioned cases, go to your dealer for service.

Blank display

Display the blank.

To Reset the Information

Select the page in the INFO area that containing the item you want to reset with ◀ or ▶ of the sel switch. ➡P.26

Press and hold the [Fn] function switch until the background colour of the information item changes.

- ▶ If there is no resettable information item on the page, there is no response to the switch operation.
- ▶ If there are multiple resettable information items on the same page, use ◀ or ▶ of the sel switch to select the item.

Press and hold ▲ on the sel switch until the information item is reset.

To exit the reset mode, press and hold the [Fn] function switch.

Also, the tripmeter A, tripmeter A fuel consumption, and tripmeter A average fuel mileage can be automatically reset when the reserve fuel indicator goes off after refueling. You can switch the automatic reset mode.

➡P.44 ➡P.51

Instruments (Continued)

Setting mode

To shift to the setting mode

Push and hold the sel switch in the direction of .

To select the setting menu, operate the     sel switch on the left handlebar.

▶ While the setting mode is displayed, the clock, indicators, and speed are displayed at the top of the screen.

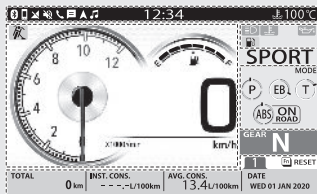

Ordinary display

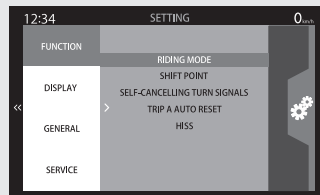

Setting mode





To return to the ordinary display

- Press and hold the  function switch.
- Push and hold the sel switch in the direction of , return to the upper hierarchy.
- The button is not pressed for about 30 seconds.
- Turn the electrical system is off and on again.

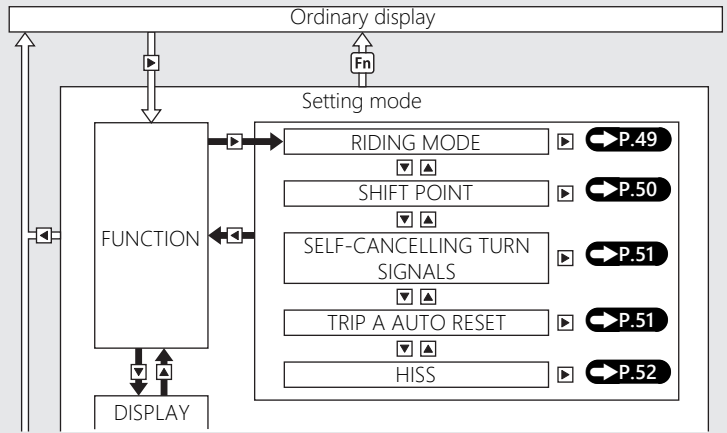
Setting flow



-  **Push/Press**
-  **Push and hold/Press and hold**

Instruments *(Continued)*

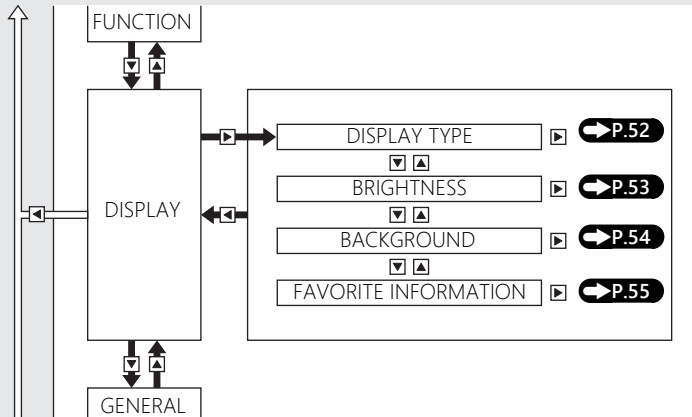

 **Push/Press**

 **Push and hold/Press and hold**

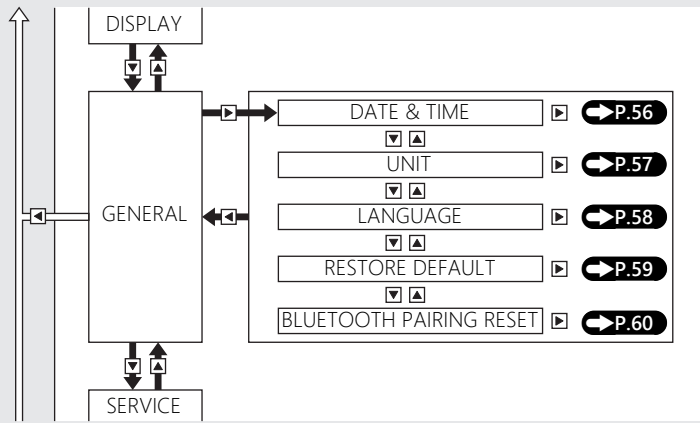

➡ Push/Press
➞ Push and hold/Press and hold

Instruments (Continued)

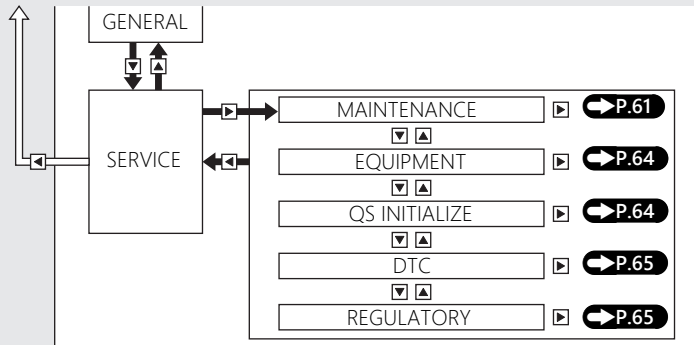







➡ Push/Press

⇨ Push and hold/Press and hold

RIDING MODE  **P.83**



You can change the setting value of the [USER].

- 1 Select the parameter ("P", "EB", "T", or "ABS") using  or  of the sel switch.
- 2 Select the desired setting value using  or  of the sel switch.
- 3 Return to the ordinary display to complete the setting.  **P.26**

To continue setting, push and hold the sel switch in the direction of  to return to the upper hierarchy.

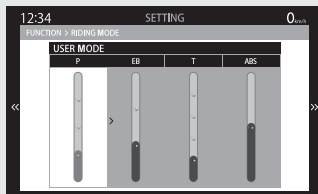
▶ The set value is retained.

**To initialize the settings:**

- 1 Push and hold the sel switch in the direction of .
- 2 Reset the setting according to the switch operation guide.  **P.26**







Instruments *(Continued)*

SHIFT POINT

ON/OFF : You can activate or deactivate the shift up mode.

SHIFT POINT : You can change the engine revolutions at which the tachometer start blinking in the shift up mode.

Shift up mode:  **P.67**

- ① Select the "ON/OFF" or "SHIFT POINT" using  or  of the sel switch.
- ② Select to the desired setting according to the switch operation guide.  **P.26**
- ③ Return to the ordinary display to complete the setting.  **P.44**

To continue setting, push and hold the sel switch in the direction of  to return to the upper hierarchy.

▶ The set value is retained.

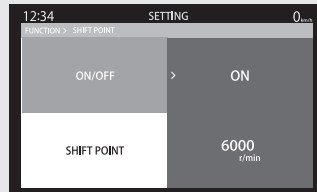

SELF-CANCELLING TURN SIGNALS

You can enable or disable turn signal automatic cancellation. ➔P.74

- 1 Select the "ON" or "OFF" using ▲ or ▼ of the sel switch.
- 2 Return to the ordinary display to complete the setting. ➔P.44

To continue setting, push the sel switch in the direction of ◀ to return to the upper hierarchy.

▶ The set value is retained.

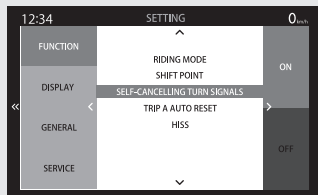

TRIP A AUTO RESET

You can enable or disable the tripmeter A automatic reset mode. ➔P.43

- 1 Select the "ON" or "OFF" using ▲ or ▼ of the sel switch.
- 2 Return to the ordinary display to complete the setting. ➔P.44

To continue setting, push the sel switch in the direction of ◀ to return to the upper hierarchy.

▶ The set value is retained.

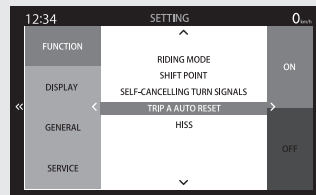





Continued 51

Instruments (Continued)

HISS

You can ON (blinks) or OFF (off) the HISS.

- 1 Select the "ON" (blinks) or "OFF" (off) using  or  of the sel switch.
- 2 Return to the ordinary display to complete the setting.  **P.44**

To continue setting, push the sel switch in the direction of  to return to the upper hierarchy.

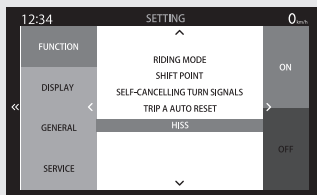

▶ The set value is retained.



DISPLAY TYPE

You can change the display type of speedometer / tachometer / fuel gauge.

 **P.27**

- 1 Select the display type ("TYPE 1", "TYPE 2", "TYPE 3", or "TYPE 4") using  or  of the sel switch.
- 2 Return to the ordinary display to complete the setting.  **P.44**

To continue setting, push and hold the sel switch in the direction of  to return to the upper hierarchy.

▶ The set value is retained.

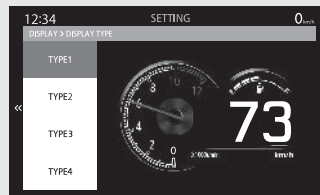

BRIGHTNESS

You can adjust the backlight brightness to one of the eight levels or select the auto adjustment.

Automatic brightness control: ➡ P.157

The display can become dark when the display is very hot. If it does not restore the original brightness, contact your dealer.

- ① Select the backlight brightness using ▲ or ▼ of the sel switch.
- ② Return to the ordinary display to complete the setting. ➡ P.44

To continue setting, push the sel switch in the direction of ◀ to return to the upper hierarchy.

▶ The set value is retained.

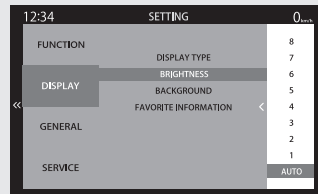

Instruments *(Continued)*

BACKGROUND

You can change the setting of the background to one of the three colours or select the auto adjustment.

Automatic Background Control:

➔ P.157

- ① Select the background colour using ▲ or ▼ of the sel switch.
- ② Return to the ordinary display to complete the setting. ➔ P.44

To continue setting, push the sel switch in the direction of ◀ to return to the upper hierarchy.

▶ The set value is retained.

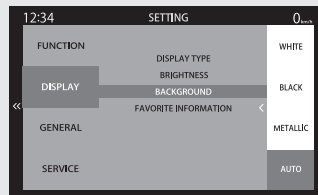

FAVORITE INFORMATION

You can change the information items displayed in the INFO area. ➡ **P.31**

- 1 Select the page of the INFO area ("INFO1", "INFO2", "INFO3", or "INFO4") using ▲ or ▼ of the sel switch.
- 2 Select to the desired setting according to the switch operation guide. ➡ **P.26**
 - ▶ If you select the item already selected in another area, the previous selected item will automatically turn the "BLANK."
- 3 Return to the ordinary display to complete the setting. ➡ **P.44**

To continue setting, push and hold the sel switch in the direction of ◀ to return to the upper hierarchy.

 - ▶ The set value is retained.

INFO 1	TOTAL	INST. CONS.	AVG. CONS.	DATE
INFO 2	TRIP A	TRIP A CONS.	TRIP A AVG. CONS.	ELAPSED
INFO 3	TRIP B	TRIP B CONS.	TRIP B AVG. CONS.	VOLTAGE
INFO 4	FUEL CONS.	AVG. CONS. **	RES TRIP	RES FUEL CONS.

Instruments *(Continued)*

DATE & TIME

- ① Select the "24 / 12", "YEAR", "MONTH - DAY", "HOUR - MINUTE", and "am / pm" using ▲ or ▼ of the sel switch.
- ② Select the desired setting according to the switch operation guide. ➡ **P.26**
 - ▶ When "24 / 12" is set to 24-hour indication, "am / pm" cannot be usable.
- ③ Return to the ordinary display to complete the setting. ➡ **P.44**



To continue setting, push and hold the sel switch in the direction of ◀ to return to the upper hierarchy.

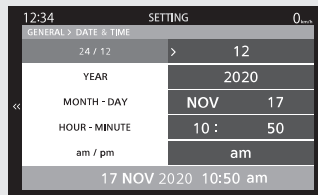

 - ▶ The set value is retained.



UNIT

You can change the speed and mileage, and fuel mileage meter units.

- 1 Select the "SPEED" or "FUEL CONS." using  or  of the sel switch.
▶ "TEMP" is displayed but not usable.
- 2 Select the desired setting according to the switch operation guide.  **P.26**

- 3 Return to the ordinary display to complete the setting.  **P.44**
To continue setting, push and hold the sel switch in the direction of  to return to the upper hierarchy.
▶ The set value is retained.

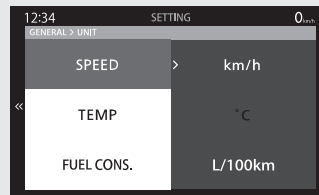

If you select "km/h" for speed unit, you can select "L/100km" or "km/L" for fuel consumption unit.

If you select "mph" for speed unit, you can select "mile/gal" or "mile/L" for fuel consumption unit.

Instruments *(Continued)*

LANGUAGE

Changes the system language.

- 1 Select the language using ▲ or ▼ of the sel switch.
- 2 Return to the ordinary display to complete the setting. ➔ P.44
To continue setting, push the sel switch in the direction of ◀ to return to the upper hierarchy.
▶ The set value is retained.

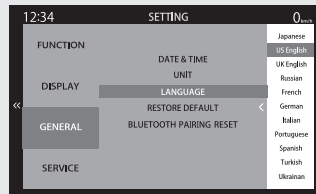

RESTORE DEFAULT

The set values can be returned to the default settings.

Reset the settings according to the switch operation guide.  **P.26**



The following items are restored to their default values:

- RIDING MODE
 - ▶ The riding mode currently selected is also initialized.
- SHIFT POINT
- SELF-CANCELLING TURN SIGNALS
- TRIP A AUTO RESET
- HISS
- DISPLAY TYPE
- BRIGHTNESS
- BACKGROUND
- FAVORITE INFORMATION
 - ▶ The page of the currently selected INFO area is also initialized.
- DATE & TIME
 - ▶ 12/24 settings are not initialized.
- UNIT
- LANGUAGE

Instruments (Continued)

BLUETOOTH PAIRING RESET

You can reset the pairing record of *Bluetooth*®.

To connect the device ➔P.79

Reset the settings according to the switch operation guide. ➔P.26



- ▶ If the pairing information remains in your smartphone even if the pairing information is deleted from the vehicle, the smartphone may be connected to the vehicle again.

MAINTENANCE

You can check the next periodic inspection time and next engine oil change.

You can change the setting of the next periodic inspection and next engine oil change.

Next periodic inspection

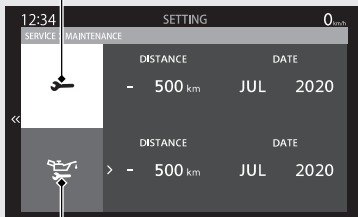

Next engine oil change

Display range:

DISTANCE:

"": (periodic inspection):

-----, 12,000 to -99,900 km (8,000 to -99,950 mile)

"": (engine oil change):

-----, 12,000 to -99,980 km (8,000 to -99,980 mile)

- ▶ Pass 0 km (0 mile): "-" mark is displayed.
- ▶ If you change the SPEED unit from "mile" to "km", it may be displayed ranges over 12,000 km depending on the set distance.

DATE:

Month: ---, JAN to DEC

Year: ----, 2020 to 2119

Instruments *(Continued)*





The pop-up information appears in the ordinary display when it reaches either of the following.  **P.66**

- 500 km (300 mile) from the next periodic inspection.
- 100 km (60 mile) from the next engine oil change.
- One month before the set month.





Maintenance pop-up information

Next inspection setting

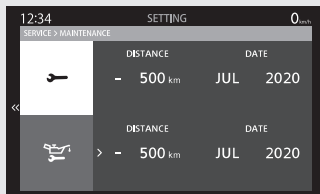
- 1 Select “” (periodic inspection) or “” (engine oil change) using  or  of the sel switch.



- 2 Select the desired setting according to the switch operation guide.
 - ▶ If you press and hold  of the sel switch while setting the “DISTANCE”, it will move every 1000.
 - ▶ Available setting range of the DISTANCE: -----, 100 to 12,000 km (100 to 8,000 mile)
 - ▶ Year displays “---” if you select “---” in month setting.
- 3 Return to the ordinary display to complete the setting.  **P.44**
To continue setting, push and hold the sel switch in the direction of  to return to the upper hierarchy.

Instruments *(Continued)*

EQUIPMENT

"EQUIPMENT" is displayed but not selectable.

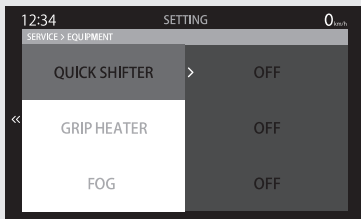

QS INITIALIZE

"QS INITIALIZE" is displayed but not selectable.

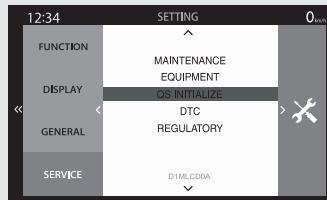

DTC

Displays a current problem with the vehicle. If your vehicle has problem, DTC index is displayed.

Reduce speed and have your vehicle inspected by your dealer as soon as possible.

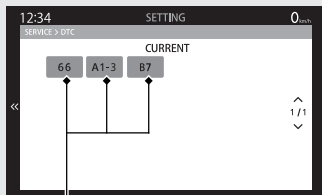

DTC indexes

REGULATORY

Displays the radio wave authentication screen.

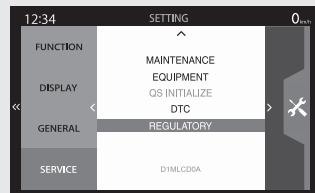

Instruments *(Continued)*

Pop-up information



In the following cases, pop-up information is displayed at the INFO area.





- Maintenance information:

When the inspection time of your vehicle is approaching.

When your vehicle has multiple pieces of information, pop-up information display appears alternately.

Maintenance Information

Indication	Explanation	Remedy
 DISTANCE 900km DATE JAN 2021	When the periodic inspection time of your vehicle is approaching.	Have your vehicle inspected by your dealer.
 DISTANCE 200km DATE JAN 2021	When the oil change time of your vehicle is approaching.	Change the engine oil.

You can hide the pop-up information by pushing either the     sel switch or  function switch while the pop-up information is displayed.

Tachometer colour function

Shift Up Mode

When shift up mode is ON, the tachometer colour changes according to the shift point setting.

To set the shift up mode  **P.44**

 **P.50**

The tachometer blinks yellow when the engine revolutions exceeds the set value of SHIFT POINT.

Indicators

If one of these indicators does not come on when it should, have your dealer check for problems. Refer to the "Instruments" about indicators appeared on the display: **➡P.30**

⇐ **Left turn signal indicator**

⇒ **Right turn signal indicator**

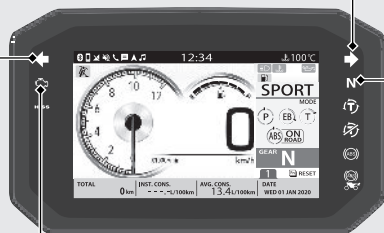

N **Neutral indicator**

Comes on when the transmission is in Neutral.

 **PGM-FI (Programmed Fuel Injection) malfunction indicator lamp (MIL)**

Comes on briefly when the ignition switch is turned to **I** (On) position.

If it comes on or flashes while engine is running: ➡P.142



ABS (Anti-lock Brake System) indicator

- Comes on when the ignition switch is turned to **I** (On) position.
- Goes off when your speed reaches approximately 10 km/h (6 mph).

If it comes on while riding:  **P.143**

Rear ABS (Anti-lock Brake System) OFF indicator

- Comes on when the ignition switch is turned to **I** (On) position.
- Comes on when the ABS function on the rear wheel is turned off.  **P.77**

Indicators (Continued)



Torque Control indicator

- Comes on when the electrical system is turned on. Goes off when your speed reaches approximately 5 km/h (3 mph) to indicate Torque Control is ready to work.
- Blinks when Torque Control is operating.

If it comes on while riding: ➡ P.144

Torque Control OFF Indicator

- Comes on when the Torque Control is turned Off.

HISS indicator ➡ P.139

- Flashes every 2 seconds for 24 hours when the ignition switch is turned to the  (Off) position.
- You can switch HISS indicator flashing. ➡ P.52

Switches

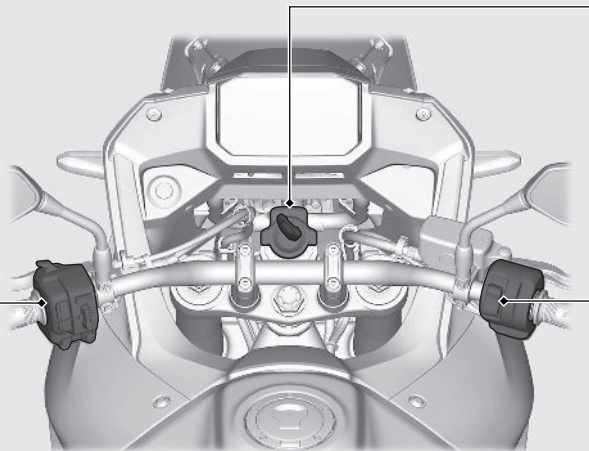

Left handlebar switch ➔ P.74



Engine stop switch/  Start button

Should normally remain in the  (Run) position.

▶ In an emergency, switch to the  (Stop) position to stop the engine.

Ignition Switch

Switches the electrical system on/off, locks the steering.

- ▶ Key can be removed when in the  (Off) or  (Lock) position.

 (On)
Turns electrical system on for starting/riding.

 (Off)
Turns engine off.

 (Lock)
Locks steering.

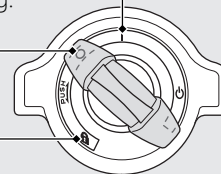

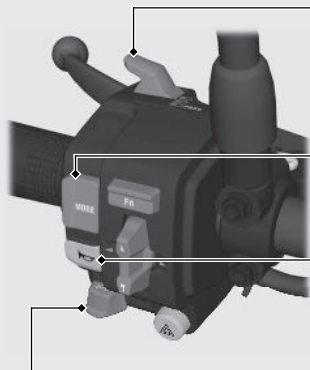

Switches *(Continued)*

Left handlebar switches



Headlight dimmer/Passing light control switch

-  : High beam
-  : Low beam
-  **PASS** : Flashes the high beam headlight.

MODE switch

Use to change the riding mode.  **P.83**

Horn button

Turn signal switch

The turn signal will automatically stop when you complete the turn. (You can manually cancel the lights by pressing the switch in.) When used for a lane change, the turn signal will automatically stop in about 7 seconds or after riding 150 m (164 yards). In some cases, the timing at which the turn signal stops could be sooner or later. Always use the recommended tyres to ensure correct automatic cancellation operation.

To enable or disable the turn signal automatic cancellation:  **P.51**

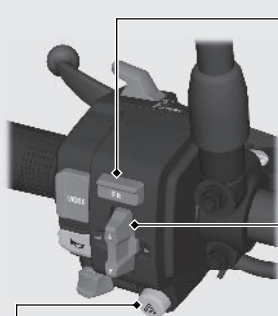

Fn Function switch

Use to operate and set the display. ➔P.26

▲ ▼ ◀ ▶ Sel switch

Use to operate and set the display. ➔P.26
Also use to set the riding mode (➔P.83) and to operate the Honda Smartphone Voice Control system. ➔P.79

▲ Hazard switch

Switchable when the ignition switch is **I** (On) position. You can turn it off regardless of ignition switch position.

- ▶ The signals continue flashing with the ignition switch in the **O** (Off) position or the **L** (Lock) position after the hazard switch is on.

Switches *(Continued)*

Steering Lock

Lock the steering when parking to help prevent theft.

A U-shaped wheel lock or similar device is also recommended.

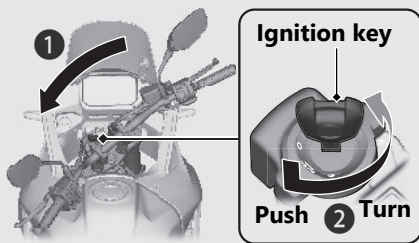

Locking

- 1 Turn the handlebar all the way to the left.
- 2 Push the key down, and turn the ignition switch to the  (Lock) position.
 - ▶ Jiggle the handlebar if the lock is difficult to engage.
- 3 Remove the key.

Unlocking







Insert the key, push it in, and turn the ignition switch to the  (Off) position.

ABS function on the rear wheel

The ABS function on the rear wheel can be optionally turned off for off-road riding. You can turn off the rear wheel ABS function while riding mode is [USER] and ABS level is 1 (OFF ROAD).

- ▶ Each time the ignition switch is turned to the **I** (On) position, the ABS function on both wheels will automatically be turned on.
- ▶ When you change the riding mode, the ABS function on both wheels will automatically be turned on.

To turn off the ABS function on the rear wheel



- 1 Stop the vehicle.
- 2 Set the riding mode to [USER].  **P.86**
- 3 Select the ABS level to 1 (OFF ROAD).  **P.87**
- 4 Press and hold the  button on the sel switch.
- 5 Select "YES" by pressing the  or  on the sel switch and press the  on the sel switch.

CANCEL
ABS RR?
YES 
NO

- ▶ The rear ABS OFF indicator turns on when the ABS function on the rear wheel is turned off.

ABS function on the rear wheel *(Continued)*

To turn on the ABS function on both wheels

- ① Stop the vehicle.
 - ② You can turn on the ABS function on the rear wheel by one of following.
 - Select the ABS in the riding mode setting and change the ABS level.
➡ **P.87**
 - Change the riding mode. ➡ **P.86**
 - Turn the ignition switch to  (Off) position and then turn it to  (On) position.
 - Initialize [USER] settings. ➡ **P.49**
 - Initialize meter settings. ➡ **P.59**
- ▶ The rear ABS OFF indicator turns off when the ABS function on rear wheel is turned on.

Honda Smartphone Voice Control system

Connecting your smartphone with the vehicle and a *Bluetooth*® headset via *Bluetooth*® allows you to operate the smartphone by voice input from the headset. You can also use the system by operating switches on the handlebar.

- ▶ To use the system, you need to install the dedicated application on your smartphone beforehand and pair your smartphone with the vehicle and the headset.

For terms of service and information on how to install/operate the dedicated application, see the following URL:

<https://global.honda/voice-control-system/>



- ▶ The dedicated application is not available in some regions/countries. For available countries, see the above URL.

Honda Smartphone Voice Control system *(Continued)*

Communication range:

Within 1 meters radius from vehicle

Supported *Bluetooth*[®] version/profiles

<i>Bluetooth</i> [®] version	Bluetooth 4.2 or higher
<i>Bluetooth</i> [®] profiles	GATT (Generic Attribute Profile)
	HOGP (HID over GATT Profile)

Bluetooth[®] Wireless Technology

The *Bluetooth*[®] word mark and logos are registered trademarks owned by Bluetooth SIG, Inc., and any use of such marks by Honda Motors Co., Ltd., is under license. Other trademarks and trade names are those of their respective owners.

- Costs of network communication and communication equipment necessary for the use of this feature shall be borne by the user.
- You cannot pair two or more smartphones at once.
- Some smartphones may not be compatible with the feature.
- We shall not be liable for any damages or trouble in the use of smartphone.
- When unable to connect your smartphone to the vehicle, change the storage location of the smartphone.

The system itself has certain limitations. Therefore, you must verify the voice guidance and information in the meter provided by the system by carefully observing the roadway, signs, and signals, etc. If you are unsure, proceed with caution. Always use your own good judgement, and obey traffic laws while riding.

⚠ WARNING

Using the Honda Smartphone Voice Control system while riding can take your attention away from the road, causing a crash in which you could be seriously injured or killed.

- Be especially cautious when crossing intersections, in heavy traffic, etc.
- Observe the roadway, signs, and signals, carefully.
- Obey traffic laws while riding.

Honda Smartphone Voice Control system Limitations

Changes in operating systems, hardware, software, and other technology integral to providing Honda Smartphone Voice Control system functionality, as well as new or revised governmental regulations, may result in a decrease or cessation of Honda Smartphone Voice Control system functionality and services.

Honda cannot and does not provide any warranty or guarantee of future Honda Smartphone Voice Control system performance or functionality.

Honda Smartphone Voice Control system *(Continued)*

Pairing your smartphone via *Bluetooth*[®]

- ① Select the BLUETOOTH PAIRING RESET menu. ➡ P.60



- ② Reset the pairing information according to the switch operation guide. ➡ P.26

- ③ After resetting, complete pairing while the *Bluetooth*[®] indicator flashing by operated the application on your smartphone.

- ▶ When the display returns to the ordinary display, the *Bluetooth*[®] indicator is flashing.



***Bluetooth*[®] indicator**

- ▶ For operation of the application, follow the instruction of the application.
- ▶ Make a *Bluetooth*[®] pairing after stopping at a safe place.

Riding mode

You can change the riding mode.
The riding mode consists of the following parameters.

P: Engine output level
EB: Engine brake level
T: Torque control level
ABS: ABS level

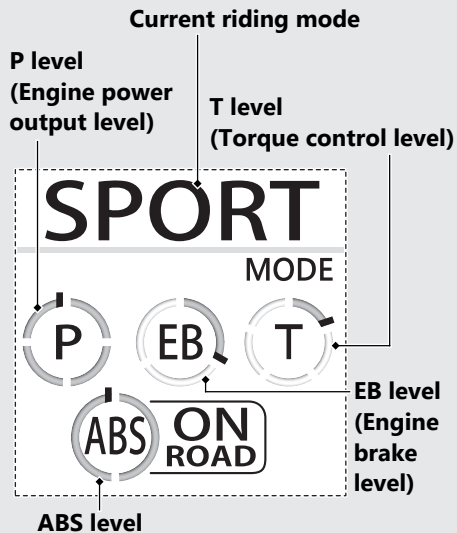

Riding mode *(Continued)*

Riding mode has five modes.

Available riding modes: [SPORT], [STANDARD], [RAIN], [GRAVEL], and [USER]

[SPORT] : This mode is suitable for sports riding. You can feel the higher engine response compared to STANDARD.

[STANDARD] : Standard, all-round mode for a variety of situations.

[RAIN] : Good for stable riding on slippery surfaces such as rainy conditions.

Initial setting

	P level	EB level	T level	ABS mode
SPORT	4	1	1	2 (ON ROAD)
STANDARD	3	2	3	2 (ON ROAD)
RAIN	1	2	5	2 (ON ROAD)
GRAVEL	2	3	4	1 (OFF ROAD)
USER	1 ^{*1}	1 ^{*1}	5 ^{*1, 2}	1 (OFF ROAD) ^{*1, 3}

Notes:

*1 : Level can be changed.

*2 : If 0 is selected, the level will change to 5 the next time the ignition switch is turned to **I** (On) position.

*3 : If the ABS function on the rear wheel is turned off, it will turn on when the ignition switch is turned to **I** (On) position next time.

[GRAVEL] : Good for stable riding on slippery surfaces such as dirt roads.

Each initial setting level cannot be changed.

[USER]

Each initial setting level can be changed.

P level (Engine power output level)

P level has four setting levels.

Available setting range: 1 to 4

- ▶ Level 1 has the least power.
- ▶ Level 4 has the most power.

EB level (Engine brake level)

EB level has three setting levels.

Available setting range: 1 to 3

- ▶ Level 1 has the weakest engine braking effect.
- ▶ Level 3 has the strongest engine braking effect.

T level (Torque control level)

T level has five setting levels and can be turned off.

Available setting range: 0 to 5

- ▶ Level 1 is the minimum Torque Control level.
- ▶ Level 5 is the maximum Torque Control level.
- ▶ Level 0 deactivates the Torque Control.
- ▶ If the electrical system is turned from off to on while the T level is set to 0, the T level is automatically set to 5.

ABS level

ABS level has two setting levels.

Available setting range: 1 (OFF ROAD) or 2 (ON ROAD)

The ABS function on rear wheel can be turned off.  **P.77**

Riding mode *(Continued)*

Selecting the riding mode

You can select the riding mode from [SPORT], [STANDARD], [RAIN], [GRAVEL], and [USER].

- 1 Stop the vehicle.
- 2 Press the **MODE** switch with the throttle fully closed.

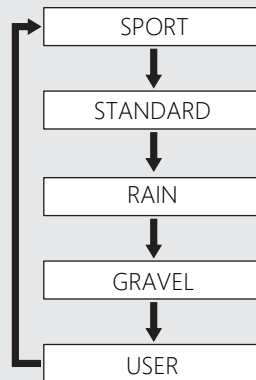
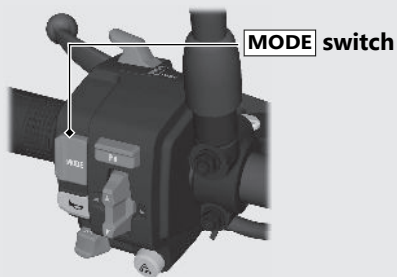

→ Press the **MODE** switch

Setting the riding mode

You can change the P, EB, T, and ABS levels on the [USER] of the riding mode.

- ① Stop the vehicle.
- ② Select the [USER] in the riding mode.
➡ P.86
- ③ Press and hold the **MODE** switch until P level starts flashing.

- ④ Select the desired parameters and setting levels.
 - ▶ To select the parameters, push the sel switch in the direction of ◀ or ▶.
 - ▶ To select the setting levels, press ▲ or ▼ on the sel switch.
 - ▶ You can change T level to 0 (off) by pressing and holding ▲ on the sel switch while T parameter is selected.
 - ▶ You can turn off the ABS function on the rear wheel by pressing and holding ▲ on the sel switch while the ABS level is 1 (OFF ROAD) and select "YES." ➡ P.77
- ⑤ Press and hold the **MODE** switch until the parameter stops flashing.

You can also change the [USER] settings in the meter setting mode. ➡ P.44 ➡ P.49

Riding mode *(Continued)*

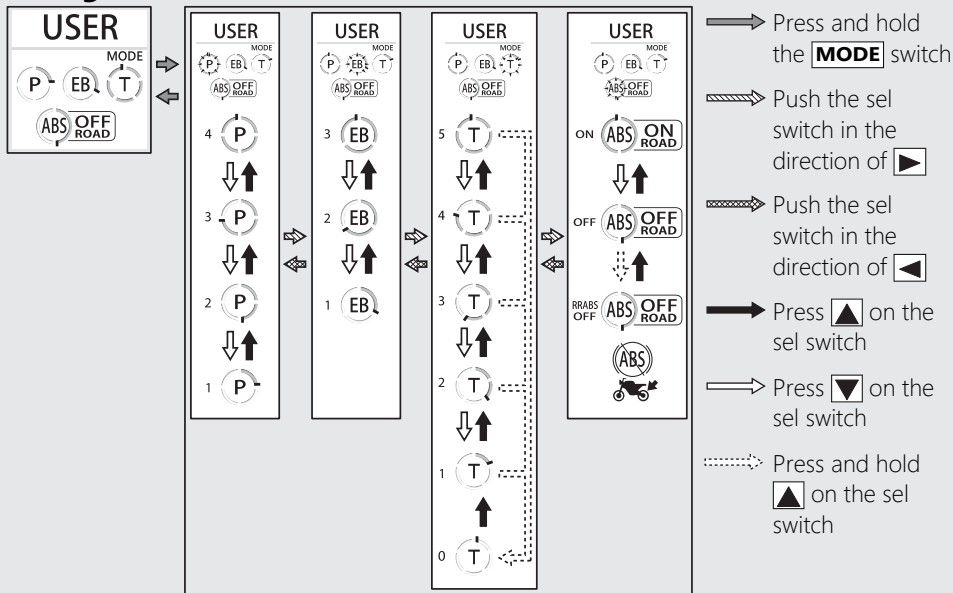

Starting the Engine

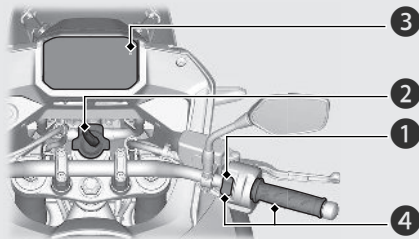

Start your engine using the following procedure, regardless of whether the engine is cold or warm.



NOTICE

- If the engine does not start within 5 seconds, turn the ignition switch to the **O** (Off) position and wait 10 seconds before trying to start the engine again to recover battery voltage.
- Extended fast idling and revving the engine can damage the engine and the exhaust system.
- Snapping the throttle or fast idling for more than about 5 minutes may cause exhaust pipe discoloration.
- The engine will not start if the throttle is fully open.

Starting the Engine *(Continued)*

- ① Make sure the engine stop switch is in the  (Run) position.
- ② Turn the ignition switch to the  (On) position.
- ③ Shift the transmission to Neutral (). Alternatively, pull in the clutch lever to start your vehicle while the transmission is in gear as long as the side stand is raised.
- ④ Press the start button with the throttle completely closed.
 - ▶ If you cannot start the engine, open the throttle slightly (about 3 mm [0.1 in], without freeplay) and press the start button.

About 3 mm (0.1 in), without freeplay

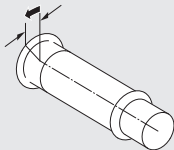

If the engine does not start:

- ① Open the throttle fully and press the start button for 5 seconds.
- ② Repeat the normal starting procedure.
- ③ If the engine starts, open the throttle slightly if idling is unstable.
- ④ If the engine does not start, wait 10 seconds before trying steps ① & ② again.

If Engine Will Not Start P.139

Shifting Gears

Your vehicle transmission has 6 forward gears in a one-down, five-up shift pattern.

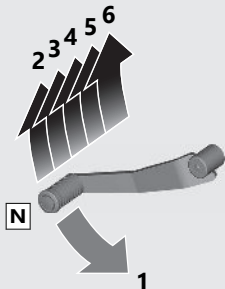

If you put the vehicle in gear with the side stand down, the engine will shut off.

Emergency Stop Signal

Emergency stop signal activates when the system detects hard braking about 50 km/h (31 mph) or above to alert drivers behind you about sudden braking by rapidly flashing both turn signal lights. This may help to alert drivers behind you to take appropriate means to avoid a possible collision with your vehicle.

The emergency stop signal stops operating when:

- You release the brakes.
- The ABS is deactivated.
- Your vehicle's decelerating speed becomes moderate.
- You press the hazard switch.

When the system activates:



1 Hard braking

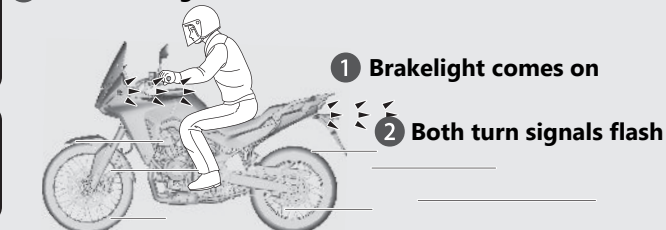

2 Both turn signal indicators blink

- ▶ The emergency stop signal is not a system that can prevent a possible rear-end collision caused by your hard braking. It is always recommended to avoid hard braking unless it is absolutely necessary.
- ▶ The emergency stop signal does not activate with the hazard switch pressed in.
- ▶ If the ABS stops working for a certain period during braking, the emergency stop signal may not activate at all.

Refuelling

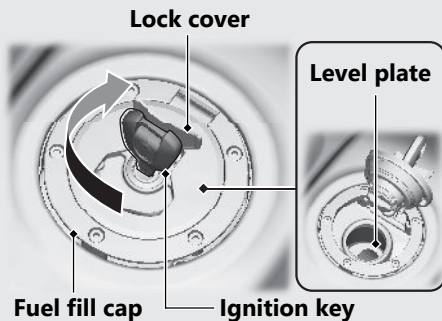

Do not fill with fuel above the level plate.

Fuel type: Unleaded petrol only

Fuel octane number: Your vehicle is designed to use Research Octane Number (RON) 91 or higher.

Tank capacity: 16.9 L (4.46 US gal, 3.72 Imp gal)

Refuelling and Fuel Guidelines **P.17**

Opening the Fuel Fill Cap

Open the lock cover, insert the ignition key, and turn it clockwise to open the cap.

Closing the Fuel Fill Cap

- ① After refuelling, push the fuel fill cap closed until it locks.
- ② Remove the key and close the lock cover.
 - ▶ The key cannot be removed if the cap is not locked.

WARNING

Petrol is highly flammable and explosive. You can be burned or seriously injured when handling fuel.

- Stop the engine, and keep heat, sparks, and flames away.
- Only handle fuel outdoors.
- Wipe up spills immediately.

USB Socket

Your vehicle is equipped with the USB socket (for USB Type-C only).

The USB socket is located under the seat.

➔ **P.119**

This socket is for battery charge only.

Use USB devices at your own risk. In no event shall Honda be liable for any damage to your USB device when in use.

Only USB devices within the following specifications can be connected.

Rated capacity is

15 W (5 V, 3.0 A).

To connect your USB device

- ➊ Remove the seat. ➔ **P.119**
- ➋ Remove the USB socket cover.
 - ▶ To prevent lost the cap, put the USB socket cover through the ring part of the cap, and then connect a certified USB cable to the USB socket.
- ➌ Connect a certified USB cable to the socket.

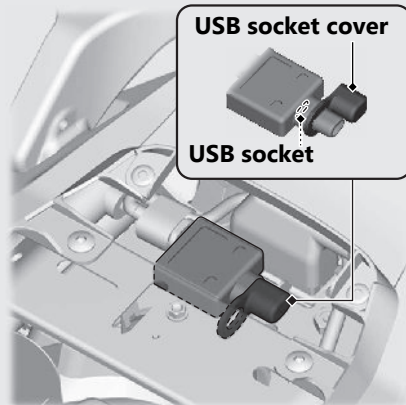

USB Socket *(Continued)*

- ▶ To prevent the battery from becoming weak (or dead), keep the engine running while drawing current from the socket.
- ▶ To prevent entry of foreign matter into the socket, be sure to close the cover.
- ▶ Carefully secure all connected devices, as vibration may cause damage to them or they could shift unexpectedly.

NOTICE

- Using any heat-generating USB devices or improperly rated USB devices can damage the socket.
- Do not use the USB socket in wet conditions, when or while washing or any other wet conditions as these will damage the USB socket.
- Do not allow the USB cable to become pinched or trapped.
- Do not allow the USB cable to interfere with the steering or controls.

Storage Equipment

Helmet Holder

The helmet holders are located under the seat.

Helmet holders **Helmet set wire**

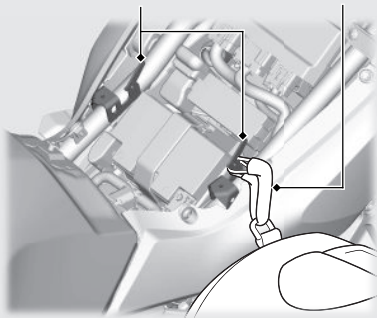

⚠️WARNING

Riding with a helmet attached to the holder can interfere with your ability to safely operate the vehicle and could lead to a crash in which you can be seriously hurt or killed.

Use the helmet holder only while parked. Do not ride with a helmet secured by the holder.

Removing the seat ➔ **P.119**

Storage Equipment *(Continued)*

Tool Kit

The tool kit is located under the seat by the rubber strap.

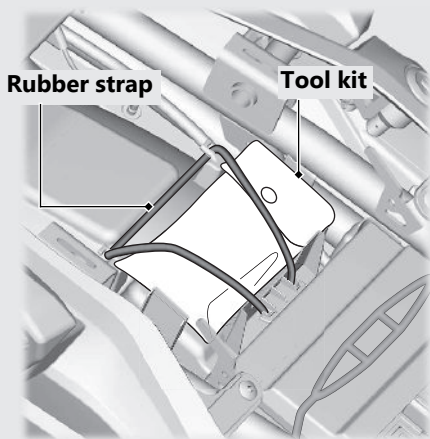

Removing the seat  P.119

Document Bag

The document bag is located on the underside of the seat by the rubber strap.

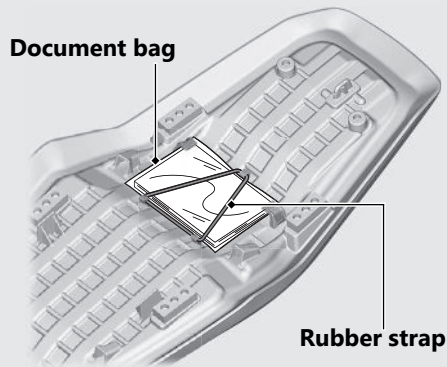

Removing the seat  P.119

Maintenance

Please read “Importance of Maintenance” and “Maintenance Fundamentals” carefully before attempting any maintenance. Refer to “Specifications” for service data.

Importance of Maintenance	P. 100	Clutch	P. 131
Maintenance Schedule	P. 101	Throttle	P. 134
Maintenance Fundamentals	P. 104	Other Adjustments	P. 135
Tools	P. 116	Adjusting the Brake Lever	P. 135
Removing & Installing Body		Adjusting the Front Suspension	P. 136
Components	P. 117	Adjusting the Rear Suspension.....	P. 137
Battery.....	P. 117		
Seat.....	P. 119		
Engine Oil	P. 120		
Coolant	P. 122		
Brakes	P. 124		
Side Stand	P. 127		
Drive Chain	P. 128		
Wheels	P. 130		

Importance of Maintenance

Importance of Maintenance

Keeping your vehicle well-maintained is absolutely essential to your safety and to protect your investment, obtain maximum performance, avoid breakdowns, and reduce air pollution. Maintenance is the owner's responsibility. Be sure to inspect your vehicle before each ride and perform the periodic checks specified in the Maintenance Schedule.

➤ P. 101

⚠ WARNING

Improperly maintaining your vehicle or failing to correct a problem before you ride can cause a crash in which you can be seriously hurt or killed.

Always follow the inspection and maintenance recommendations and schedules in this owner's manual.

Maintenance Safety

Always read the maintenance instructions before you begin each task and make sure that you have the tools, parts, and skills required. We cannot warn you of every conceivable hazard that can arise in performing maintenance. Only you can decide whether or not you should perform a given task.

Follow these guidelines when performing maintenance.

- Stop the engine and remove the key.
- Place your vehicle on a firm, level surface using the side stand or a maintenance stand to provide support.
- Allow the engine, muffler, brakes, and other high-temperature parts to cool before servicing as you can get burned.
- Run the engine only when instructed, and do so in a well-ventilated area.

Maintenance Schedule

The maintenance schedule specifies the maintenance requirements necessary to ensure safe, dependable performance, and proper emission control.

Maintenance work should be performed in accordance with Honda's standards and specifications by properly trained and equipped technicians. Your dealer meets all of these requirements. Keep an accurate record of maintenance to help ensure that your vehicle is properly maintained. Make sure that whomever performs the maintenance completes this record.

All scheduled maintenance is considered a normal owner operating cost and will be charged to you by your dealer. Retain all receipts. If you sell the vehicle, these receipts should be transferred with the vehicle to the new owner.

Honda recommends that your dealer should road test your vehicle after each periodic maintenance is carried out.

Maintenance Schedule

Items	Pre-ride Check ☒ P. 104	Frequency*1						Annual Check	Regular Replace	Refer to page
		× 1,000 km	1	12	24	36	48			
		× 1,000 mi	0.6	8	16	24	32			
Honda Diagnostic System	✂		I	I	I	I	I			
Fuel Line	✂			I	I	I	I	I		-
Fuel Level		I								94
Throttle Operation	✂	I		I	I	I	I	I		134
Air Cleaner *2	✂				R		R			-
Crankcase Breather *3				C	C	C	C			-
Spark Plug	✂				I		R			-
Valve Clearance	✂				I		I			-
Engine Oil		I		R	R	R	R	R	R	-
Engine Oil Filter			R		R		R			-
Engine Idle Speed	✂			I	I	I	I	I		-
Radiator Coolant *4		I		I	I	I	I	I	3 Years	122
Cooling System	✂			I	I	I	I	I		-
Secondary Air Supply System	✂				I		I			-
Evaporative Emission Control System	✂				I		I			-

Maintenance Level

✂ : Intermediate. We recommend service by your dealer, unless you have the necessary tools and are mechanically skilled.

Procedures are provided in an official Honda Shop Manual.

✂ : Technical. In the interest of safety, have your vehicle serviced by your dealer.

Maintenance Legend

I : Inspect (clean, adjust, lubricate, or replace, if necessary)

R : Replace

L : Lubricate

C : Clean

Maintenance Schedule

Items	Pre-ride Check P. 104	Frequency*1					Annual Check	Regular Replace	Refer to page	
		× 1,000 km	1	12	24	36				48
		× 1,000 mi	0.6	8	16	24				32
Drive Chain*5	I	Every 1,000 km (600 mi): I I							128	
Drive Chain Slider*5			I	I	I	I			129	
Brake Fluid *4	I		I	I	I	I	I	2 Years	124	
Brake Pads Wear	I		I	I	I	I	I		125	
Brake System			I	I	I	I	I		104	
Brakelight Switch			I	I	I	I	I		126	
Headlight Aim			I	I	I	I	I		-	
Lights/Horn	I								-	
Engine Stop Switch	I								-	
Clutch System	I		I	I	I	I	I		131	
Side Stand	I		I	I	I	I	I		127	
Suspension	⚡		I	I	I	I	I		136	
Nuts, Bolts, Fasteners*5	⚡		I	I	I	I	I		-	
Wheels/Tyres*5	✂	I	Every 6,000 km (4000 mi): I				I		113	
Steering Head Bearings	✂			I	I	I	I	I	-	

Notes:

*1 : At higher odometer readings, repeat at the frequency interval established here.

*2 : Service more frequently when riding in unusually wet or dusty areas.

*3 : Service more frequently when riding in rain or at full throttle.

*4 : Replacement requires mechanical skill.

*5 : Service more frequently when riding OFF-ROAD.

Maintenance Fundamentals

Pre-ride Inspection

To ensure safety, it is your responsibility to perform a pre-ride inspection and make sure that any problem you find is corrected. A pre-ride inspection is a must, not only for safety, but because having a breakdown, or even a flat tyre, can be a major inconvenience.

Check the following items before you get on your vehicle:

- Fuel level - Fill fuel tank when necessary ➤ P. 94
- Throttle - Check for smooth opening and full closing in all steering positions ➤ P. 134
- Engine oil level - Add engine oil if necessary. Check for leaks ➤ P. 120
- Coolant level - Add coolant if required. Check for leaks ➤ P. 122
- Drive chain - Check condition and slack, adjust and lubricate if necessary ➤ P. 128
- Brakes - Check operation; Front and Rear: check brake fluid level and pads wear ➤ P. 124, ➤ P. 125

- Lights and horn - Check that lights, indicators and horn function properly
- Engine stop switch - Check for proper function ➤ P. 72
- Clutch - Check operation; Adjust freeplay if necessary ➤ P. 131
- Side stand ignition cut-off system - Check for proper function ➤ P. 127
- Wheels and tyres - Check condition, air pressure and adjust if necessary ➤ P. 113

Before riding off-road check all of the preceding plus the following:

- Make sure spokes are tight. Check the rims for any damage ➤ P. 130
- Be sure the fuel fill cap is securely fastened ➤ P. 94
- Check for loose cables and other parts, and anything that appears abnormal
- Use a wrench to check the tightness of all accessible nuts, bolts and fasteners

Replacing Parts

Always use Honda Genuine Parts or their equivalents to ensure reliability and safety. When ordering coloured components, specify the model name, colour, and code mentioned on the colour label.

The colour label is attached to frame under the seat.  P. 119

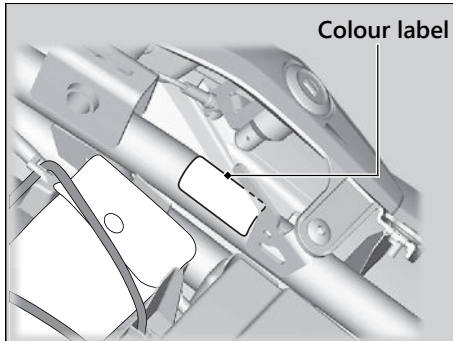

WARNING

Installing non-Honda parts may make your vehicle unsafe and cause a crash in which you can be seriously hurt or killed.

Always use Honda Genuine Parts or equivalents that have been designed and approved for your vehicle.

Maintenance Fundamentals

Battery

Your vehicle has a maintenance-free type battery. You do not have to check the battery electrolyte level or add distilled water. Clean the battery terminals if they become dirty or corroded.

Do not remove the battery cap seals. There is no need to remove the cap when charging.

NOTICE

Your battery is a maintenance-free type and can be permanently damaged if the cap strip is removed.



This symbol on the battery means that this product must not be treated as household waste.

NOTICE

An improperly disposed of battery can be harmful to the environment and human health. Always confirm local regulations for proper battery disposal instruction.

Maintenance Fundamentals

What to do in an emergency

If any of the following occur, immediately see your doctor.

- Electrolyte splashes into your eyes:
 - ▶ Wash your eyes repeatedly with cool water for at least 15 minutes. Using water under pressure can damage your eyes.
- Electrolyte splashes onto your skin:
 - ▶ Remove affected clothing and wash your skin thoroughly using water.
- Electrolyte splashes into your mouth:
 - ▶ Rinse mouth thoroughly with water, and do not swallow.

⚠ WARNING

The battery gives off explosive hydrogen gas during normal operation.

A spark or flame can cause the battery to explode with enough force to kill or seriously hurt you.

Wear protective clothing and a face shield, or have a skilled mechanic do the battery servicing.

Maintenance

Cleaning the Battery Terminals

1. Remove the battery.  P. 117
2. If the terminals are starting to corrode and are coated with a white substance, wash with warm water and wipe clean.

Maintenance Fundamentals

- If the terminals are heavily corroded, clean and polish the terminals with a wire brush or sandpaper. Wear safety glasses.

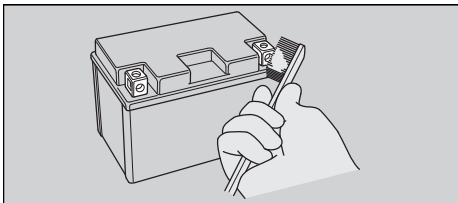

- After cleaning, reinstall the battery.

The battery has a limited life span. Consult your dealer about when you should replace the battery. Always replace the battery with another maintenance-free battery of the same type.



NOTICE

Installing non-Honda electrical accessories can overload the electrical system, discharging the battery and possibly damaging the system.

Fuses

Fuses protect the electrical circuits on your vehicle. If something electrical on your vehicle stops working, check for and replace any blown fuses.  P. 150

Inspecting and Replacing Fuses

Turn the ignition switch to the  (Off) position to remove and inspect fuses. If a fuse is blown, replace with a fuse of the same rating. For fuse ratings, see "Specifications."  P. 170

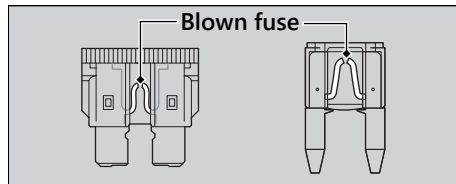

NOTICE

Replacing a fuse with one that has a higher rating greatly increases the chance of damage to the electrical system.

Maintenance Fundamentals

If a fuse fails repeatedly, you likely have an electrical fault. Have your vehicle inspected by your dealer.

Engine Oil

Engine oil consumption varies and oil quality deteriorates according to riding conditions and time elapsed.

Check the engine oil level regularly, and add the recommended engine oil if necessary. Dirty oil or old oil should be changed as soon as possible.

Selecting the Engine Oil

For recommended engine oil, see "Specifications." P. 169

If you use non-Honda engine oil, check the label to make sure that the oil satisfies all of the following standards:

- JASO T 903 standard^{*1}: MA
- SAE standard^{*2}: 10W-30
- API classification^{*3}: SJ or higher

- ^{*1}. The JASO T 903 standard is an index for engine oils for 4-stroke motorcycle engines. There are two classes: MA and MB. For example, the following label shows the MA classification.

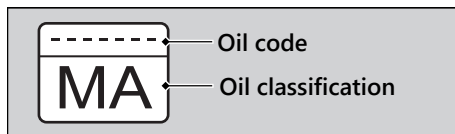

- ^{*2}. The SAE standard grades oils by their viscosity.
- ^{*3}. The API classification specifies the quality and performance rating of engine oils. Use SJ or higher oils, excluding oils marked as "Energy Conserving" or "Resource Conserving" on the circular API service symbol.

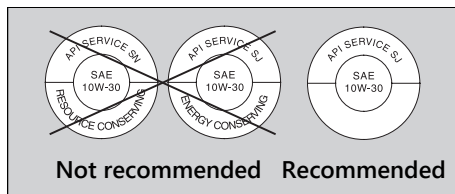

Maintenance Fundamentals

Brake Fluid

Do not add or replace brake fluid, except in an emergency. Use only fresh brake fluid from a sealed container. If you do add fluid, have the brake system serviced by your dealer as soon as possible.

NOTICE

Brake fluid can damage plastic and painted surfaces.
Wipe up spills immediately and wash thoroughly.

Recommended brake fluid:

Honda DOT 4 Brake Fluid or equivalent

Drive Chain

The drive chain must be inspected and lubricated regularly. Inspect the chain more frequently if you often ride on bad roads, ride at high speed, or ride with repeated fast acceleration.  P. 128

If the chain does not move smoothly, makes strange noises, has damaged rollers, has loose pins, has missing O-rings, or has kinks, have the chain inspected by your dealer.

Also inspect the drive sprocket and driven sprocket. If either has worn or damaged teeth, have the sprocket replaced by your dealer.



**Normal
(GOOD)**



**Worn
(REPLACE)**



**Damaged
(REPLACE)**

NOTICE

Use of a new chain with worn sprockets will cause rapid chain wear.

Maintenance Fundamentals

Cleaning and Lubricating

After inspecting the slack, clean the chain and sprockets while rotating the rear wheel. Use a dry cloth with chain cleaner designed specifically for O-ring chains, or neutral detergent. Use a soft brush if the chain is dirty. After cleaning, wipe dry and lubricate with the recommended lubricant.

Recommended lubricant:

Drive chain lubricant designed specifically for O-ring chains
If not available, use SAE 80 or 90 gear oil.

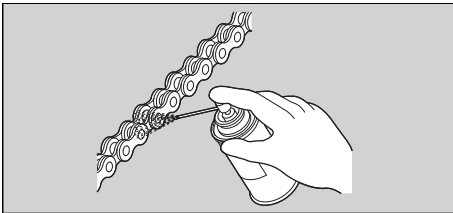

Do not use a steam cleaner, a high pressure cleaner, a wire brush, volatile solvent such as petrol and benzene, abrasive cleaner, chain cleaner or lubricant NOT designed specifically for O-ring chains as these can damage the rubber O-ring seals.

Avoid getting lubricant on the brakes or tyres.
Avoid applying excess chain lubricant to prevent spray onto your clothes and the vehicle.

Maintenance Fundamentals

Recommended Coolant

Except India and Singapore

Pro Honda HP Coolant is a pre-mixed solution of antifreeze and distilled water.

Concentration:

50% antifreeze and 50% distilled water

A concentration of antifreeze below 40% will not provide proper corrosion and cold temperature protection.

A concentration of up to 60% will provide better protection in colder climates.

NOTICE

Using coolant not specified for aluminium engines or tap/mineral water can cause corrosion.

India and Singapore

Use only genuine HONDA PRE-MIX COOLANT without diluting with water. Genuine HONDA PRE-MIX COOLANT is excellent at preventing corrosion and overheating.

The coolant should be inspected and replaced properly by following the maintenance schedule. ➤ P. 101

NOTICE

Using coolant not specified for aluminium engines or tap/mineral water can cause corrosion.

Crankcase Breather

Service more frequently when riding in rain, at full throttle, or after the vehicle is washed or overturned. Service if the deposit level can be seen in the transparent section of the drain tube. If the drain tube overflows, the air filter may become contaminated with engine oil, causing poor engine performance.

Maintenance Fundamentals

Tyres (Inspecting/Replacing)

Checking the Air Pressure

Visually inspect your tyres and use an air pressure gauge to measure the air pressure before each off-road ride and whenever you return to pavement after riding off-road. If you only ride on pavement, check the pressure at least once a month or any time you think the tyres look low. Always check air pressure when your tyres are cold.

If you decide to adjust the tyre pressure for a particular off-road riding condition, make changes a little at a time.

Inspecting for Damage

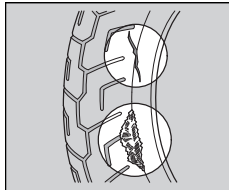

Inspect the tyres for cuts, slits, or cracks that expose fabric or cords, or nails or other foreign objects embedded in the side of the tyre or the tread.

Also inspect for any unusual bumps or bulges in the side walls of the tyres.

Inspecting for Abnormal Wear

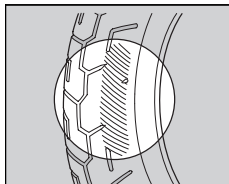

Inspect the tyres for signs of abnormal wear on the contact surface.

Maintenance Fundamentals

Inspecting Tread Depth

Inspect the tread wear indicators. If they become visible, replace the tyres immediately. For safe riding, you should replace the tyres when the minimum tread depth is reached.

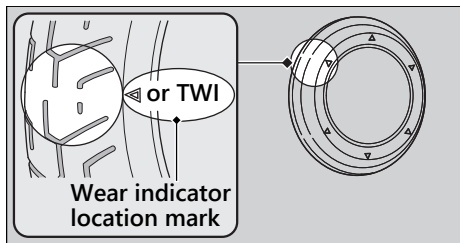

Inspecting Rims and Valve Stems

Inspect the rims for damage and loose spokes. Also inspect the valve stems for their positions. A tilted valve stem indicates the tube is slipping inside the tyre or the tyre is slipping on the rim. See your dealer.

⚠ WARNING

Riding on tyres that are excessively worn or improperly inflated can cause a crash in which you can be seriously hurt or killed.

Follow all instructions in this owner's manual regarding tyre inflation and maintenance.

Germany

German law prohibits use of tyres whose tread depth is less than 1.6 mm.

Maintenance Fundamentals

Have your tyres replaced by your dealer. For recommended tyres, air pressure, and minimum tread depth, see "Specifications."

➤ P. 169

Follow these guidelines whenever you replace tyres:

- Use the recommended tyres or their equivalents of the same size, construction, speed rating, and load range.
- Have the wheel balanced with Honda Genuine balance weights or equivalent after the tyre is installed.
- Remember to replace the inner tube whenever you replace a tyre. The old tube will probably be stretched, and it could fail if installed in a new tyre.

WARNING

Installing improper tyres on your vehicle can adversely affect handling and stability, and can cause a crash in which you can be seriously hurt or killed.

Always use the size and type of tyres recommended in this owner's manual.

Tools

The tool kit is stored under the seat.  P. 98

You can perform some roadside repairs, minor adjustments and parts replacement with the provided tools.

Maintenance

- 10 × 14 mm Open end wrench
- Standard/Phillips screwdriver
- Extension bar
- Screwdriver handle
- Pin spanner
- Fuse puller
- Helmet set wire
- 19 mm Box end wrench

Removing & Installing Body Components

Battery

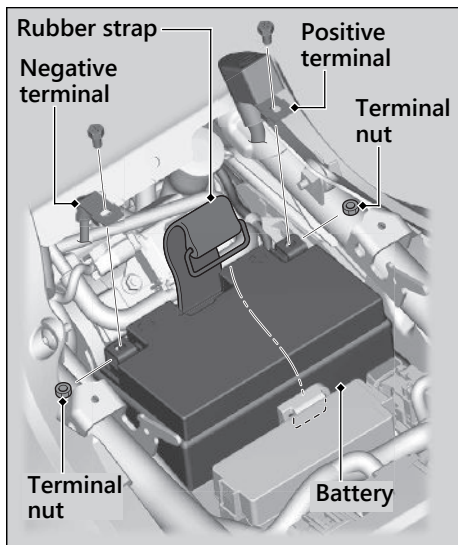

Removal

Make sure the ignition switch is in the ○ (Off) position.

1. Remove the seat. ➤ P. 119
2. Unhook the rubber strap.
3. Disconnect the negative ⊖ terminal from the battery.
4. Disconnect the positive ⊕ terminal from the battery.
5. Remove the battery, taking care not to drop the terminal nuts.

Removing & Installing Body Components ► Battery

Installation

Install the parts in the reverse order of removal. Always connect the positive ⊕ terminal first. Make sure bolts and nuts are tight.

Make sure the clock information is correct after the battery is reconnected. ► P. 56
For proper handling of the battery, see “Maintenance Fundamentals.” ► P. 106
“Battery Goes Dead.” ► P. 149

Seat

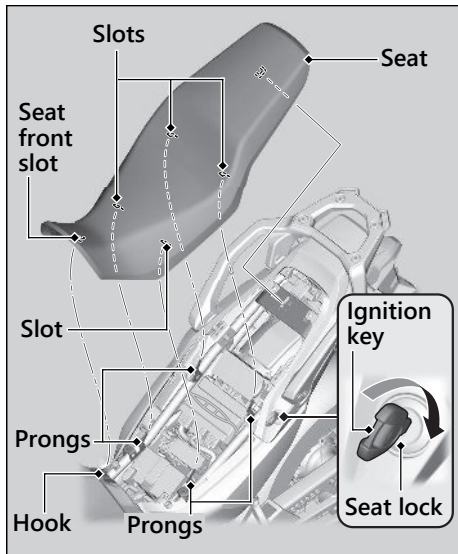

Removing & Installing Body Components ► Seat

Removal

1. Insert the ignition key into the seat lock and turn it clockwise.
2. Remove the seat by pulling it backward.

Installation

1. Install the seat aligning the seat front slot with the hook and the prongs with the slots.
2. Push forward and down the rear of the seat until it locks in place. Make sure the seat is locked securely in position by pulling it up lightly.

The seat locks automatically when closed. Take care not to lock your ignition key under the seat.

Engine Oil

Checking the Engine Oil

Maintenance

1. If the engine is cold, idle the engine for 3 to 5 minutes.
2. Turn the ignition switch to the **O** (Off) position and wait for 2 to 3 minutes.
3. Place your vehicle in an upright position on a firm, level surface.
4. Remove the oil fill cap/dipstick and wipe it clean.
5. Insert the oil fill cap/dipstick until it seats, but don't screw it in.
6. Check that the oil level is between the upper level and lower level marks on the oil fill cap/dipstick.
7. Securely install the oil fill cap/dipstick.

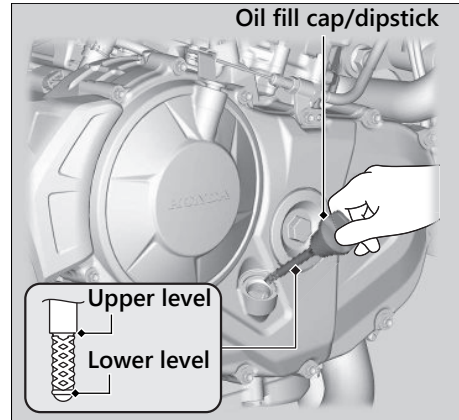

Adding Engine Oil

If the engine oil is below or near the lower level mark, add the recommended engine oil.

► P. 109, ► P. 169

1. Remove the oil fill cap/dipstick. Add the recommended oil until it reaches the upper level mark.
 - Place your vehicle in an upright position on a firm, level surface when checking the oil level.
 - Do not overfill above the upper level mark.
 - Make sure no foreign objects enter the oil filler opening.
 - Wipe up any spills immediately.

2. Securely reinstall the oil fill cap/dipstick.

NOTICE

Overfilling with oil or operating with insufficient oil can cause damage to your engine. Do not mix different brands and grades of oil. They may affect lubrication and clutch operation.

For the recommended oil and oil selection guidelines, see "Maintenance Fundamentals."

► P. 109

Coolant

Checking the Coolant

Check the coolant level in the reserve tank while the engine is cold.

1. Place your vehicle on a firm, level surface.
2. Hold your vehicle in an upright position.
3. Check that the coolant level is between the UPPER level and LOWER level marks on the reserve tank.

If the coolant level is dropping noticeably or the reserve tank is empty, you likely have a serious leak. Have your vehicle inspected by your dealer.

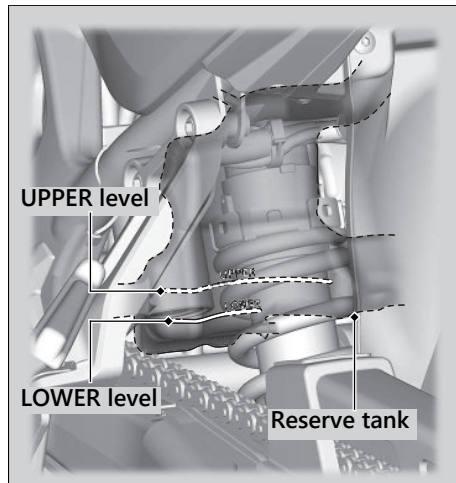

Adding Coolant

If the coolant level is below the LOWER level mark, add the recommended coolant (► P. 112) until the level reaches the UPPER level mark.

Add fluid only from the reserve tank cap and do not remove the radiator cap.

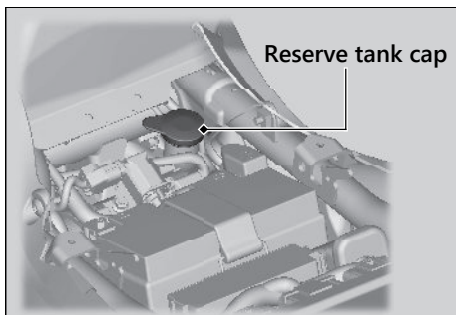

1. Remove the seat. ► P. 119
2. Remove the reserve tank cap and add fluid while monitoring the coolant level.
 - Do not overfill above the UPPER level mark.
 - Make sure no foreign objects enter the reserve tank opening.
3. Securely reinstall the reserve tank cap.
4. Install the seat.

⚠ WARNING

Removing the radiator cap while the engine is hot can cause the coolant to spray out, potentially scalding you.

Always let the engine and radiator cool down before removing the radiator cap.

Brakes

Checking Brake Fluid

1. Place your vehicle in an upright position on a firm, level surface.
2. **Front** Check that the brake fluid reservoir is horizontal and that fluid level is above the LOWER level mark.
Rear Check that the brake fluid reservoir is horizontal and that fluid level is between the LOWER level and UPPER level marks.

If the brake fluid level in either reservoir is below the LOWER level mark or the brake lever and pedal freeplay becomes excessive, inspect the brake pads for wear. If the brake pads are not worn, you most likely have a leak. Have your vehicle inspected by your dealer.

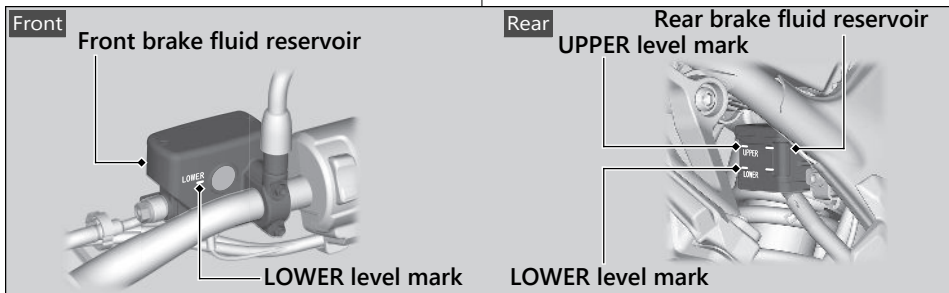

Brakes ► Inspecting the Brake Pads

Inspecting the Brake Pads

Check the condition of the brake pad wear indicators.

The pads need to be replaced if a brake pad is worn to the indicator.

1. **Front** Inspect the brake pads from below the brake caliper.
► Always inspect both left and right brake calipers.
2. **Rear** Inspect the brake pads from behind the brake caliper.

If necessary, have the pads replaced by your dealer.

Always replace both left and right brake pads at the same time.

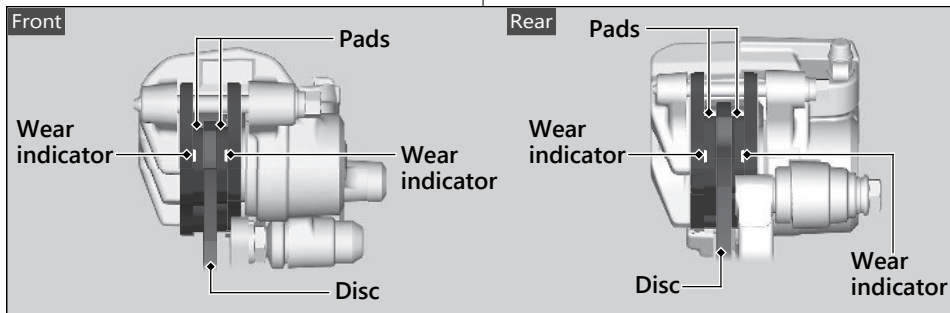

Brakes ► Adjusting the Brakelight Switch

Adjusting the Brakelight Switch

Check the operation of the brakelight switch. Hold the brakelight switch and turn the adjusting nut in the direction A if the switch operates too late, or turn the nut in the direction B if the switch operates too soon.

Maintenance

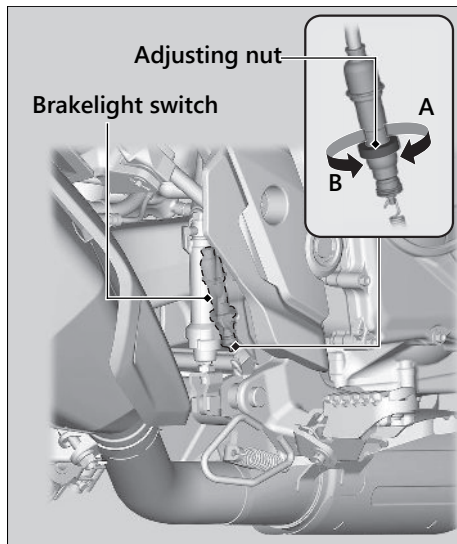

Side Stand

Checking the Side Stand

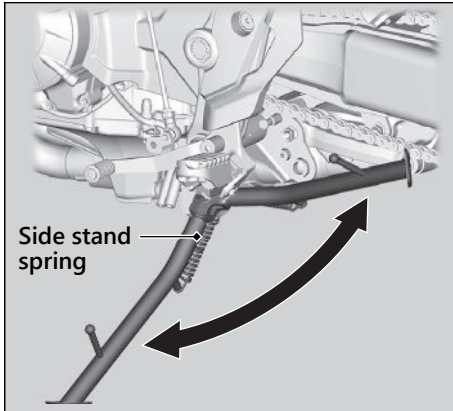

1. Check that the side stand operates smoothly. If the side stand is stiff or squeaky, clean the pivot area and lubricate the pivot bolt with clean grease.
2. Check the spring for damage or loss of tension.
3. Sit on the vehicle, shift the transmission to Neutral, and raise the side stand.
4. Start the engine, pull the clutch lever in, and shift the transmission into gear.
5. Lower the side stand all the way. The engine should stop as you lower the side stand. If the engine doesn't stop, have your vehicle inspected by your dealer.

Drive Chain

Inspecting the Drive Chain Slack

Maintenance

Check the drive chain slack at several points along the chain. If the slack is not constant at all points, some links may be kinked and binding.

Have the chain inspected by your dealer.

1. Shift the transmission to Neutral. Stop the engine.
2. Place your vehicle on its side stand on a firm, level surface.
3. Pull the upper half of the drive chain up and check the chain slack between the drive chain and swing-arm at the end of the drive chain slider.

Drive chain slack:

Swingarm to drive chain

50 - 55 mm (2.0 - 2.2 in)

- ▶ Do not ride your vehicle if the slack exceeds 60 mm (2.4 in).

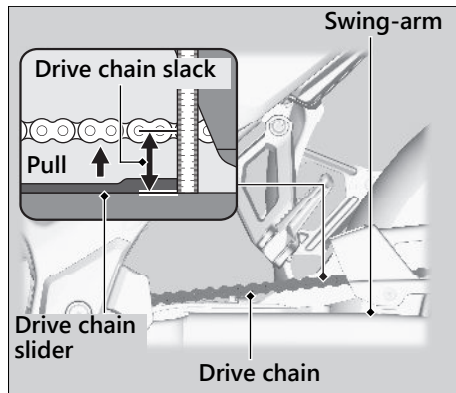

4. Roll the vehicle forward and check that the chain moves smoothly.
5. Inspect the sprockets. ➤ P. 110
6. Clean and lubricate the drive chain. ➤ P. 111

Drive Chain ► Checking the Drive Chain Slider

Checking the Drive Chain Slider

Check the condition of the drive chain slider. The drive chain slider will need to be replaced if the chain slider is worn to the wear limit line or bottom of the wear limit indicator.

If necessary, have the drive chain slider replaced by your dealer.

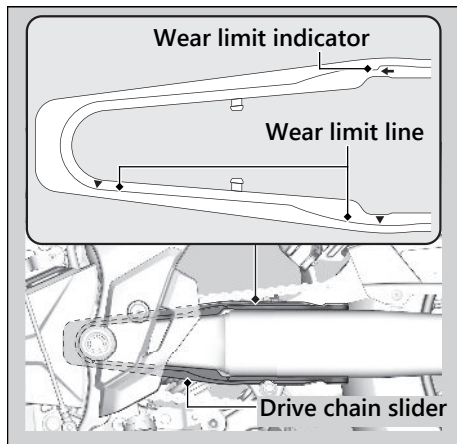

Wheels

Wheels Rims & Spokes

Keeping the wheels true (round) and maintaining correct spoke tension is critical to safe vehicle operation.

Excessively loose spokes may result in instability at high speeds and possible loss of control.

It is not necessary to remove the wheels to perform the recommended service in the Maintenance Schedule.

1. Inspect the wheel rims and spokes for damage.
2. Tighten any loose spokes.
3. Rotate the wheel slowly to see if it appears to “wobble.” If it does, the rim is out of round or not “true.” If the wobble is noticeable, see your dealer for inspection.

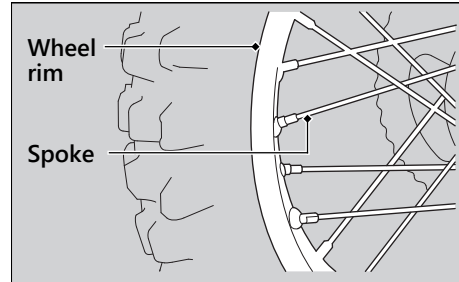

Clutch

Checking the Clutch

Checking the Clutch Lever Freeplay

Check the clutch lever freeplay.

Freeplay at the clutch lever:

10 - 20 mm (0.4 - 0.8 in)

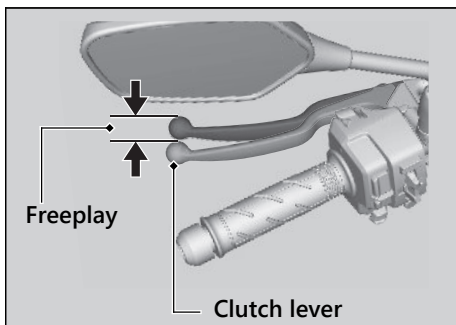

Check the clutch cable for kinks or signs of wear. If necessary, have it replaced by your dealer.

Lubricate the clutch cable with a commercially available cable lubricant to prevent premature wear and corrosion.

NOTICE

Improper freeplay adjustment can cause premature clutch wear.

Clutch ► Adjusting the Clutch Lever Freeplay

Adjusting the Clutch Lever Freeplay

I Upper Adjustment

Attempt adjustment with the upper clutch cable adjuster first.

Turn the clutch cable adjuster until the freeplay is 10 - 20 mm (0.4 - 0.8 in).

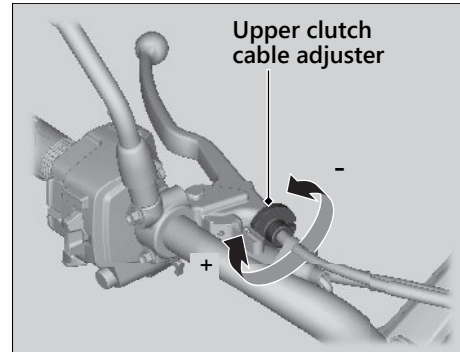

Clutch ► Adjusting the Clutch Lever Freeplay

Lower Adjustment

If the upper clutch cable adjuster is threaded out near its limit, or the correct freeplay cannot be obtained, attempt adjustment with the lower clutch cable adjusting nut.

1. Turn the upper clutch cable adjuster all the way in to provide maximum freeplay.
2. Loosen the lower lock nut.
3. Turn the adjusting nut until the clutch lever freeplay is 10 - 20 mm (0.4 - 0.8 in).
4. Tighten the lower lock nut and check the clutch lever freeplay.
5. Start the engine, pull the clutch lever in, and shift into gear. Make sure the engine does not stall and the vehicle does not creep. Gradually release the clutch lever and open the throttle. Your vehicle should move smoothly and accelerate gradually.

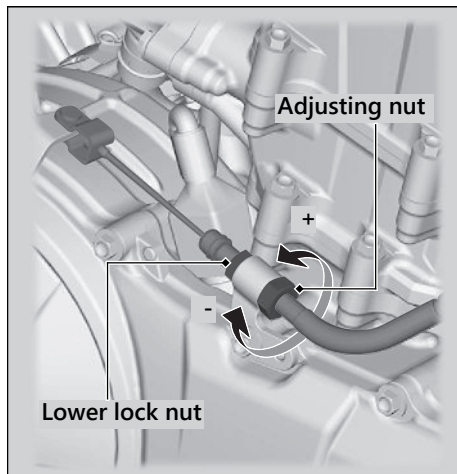

If proper adjustment cannot be obtained or the clutch does not work correctly, see your dealer.

Throttle

Checking the Throttle

With the engine off, check that the throttle rotates smoothly from fully closed to fully open. If the throttle does not move smoothly or close automatically, have the vehicle inspected by your dealer.

Maintenance

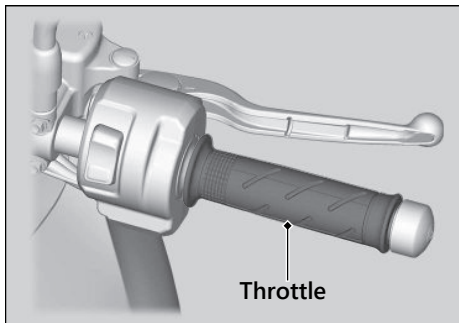

Other Adjustments

Adjusting the Brake Lever

You can adjust the distance between the brake lever and handle grip.

Adjustment method

Turn the adjuster until the numbers align with the index mark in the desired position while pushing the brake lever forward.

After adjustment, check that the lever operates correctly before riding.

NOTICE

Do not turn the adjuster beyond its natural limit.

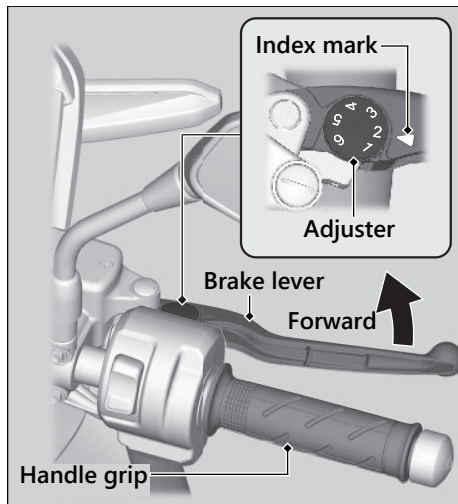

Other Adjustments ► Adjusting the Front Suspension

Adjusting the Front Suspension

I Spring Preload

You can adjust the spring preload by the adjuster to suit the load or the road surface.

Turn the adjuster using the 19 mm Box end wrench provided in the tool kit. ► P. 116

The spring preload adjuster has 15 turns. Turn clockwise to increase spring preload (hard), or turn counterclockwise to decrease spring preload (soft). The standard position is the 7 turns from the full soft position.

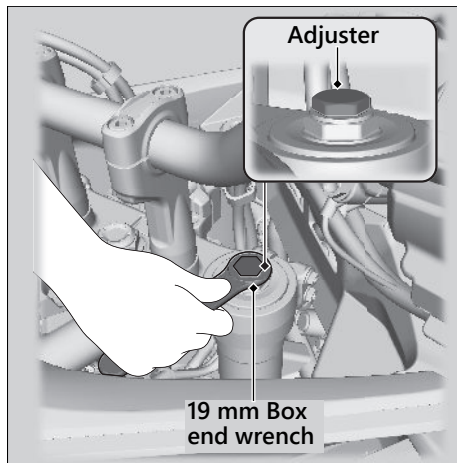

NOTICE

Do not turn the adjuster beyond its limits. Adjust both left and right forks to the same spring preload.

Other Adjustments ► Adjusting the Rear Suspension

Adjusting the Rear Suspension

I Spring Preload

You can adjust the spring preload by the adjuster to suit the load or the road surface.

Turn the adjuster using the pin spanner and extension bar provided in the tool kit. ▣ P. 116

The preload adjuster has 7 positions. Positions 1 is for a decrease spring preload (soft), or turn the position 3 to 7 to increase spring preload (hard). The standard position is 2.

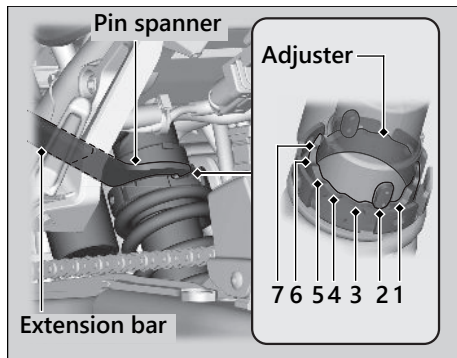

NOTICE

Do not turn the adjuster beyond its limits. Attempting to adjust directly from 1 to 7 or 7 to 1 may damage the shock absorber.

NOTICE

The rear shock absorber damper unit contains high pressure nitrogen gas. Do not attempt to disassemble, service, or improperly dispose of the damper. See your dealer.

Troubleshooting



Engine Will Not Start (HISS indicator stays on).....	P. 139
Overheating (High coolant temperature indicator is on).....	P. 140
Warning Indicators On or Flashing.....	P. 141
Low Oil Pressure Indicator.....	P. 141
PGM-FI (Programmed Fuel Injection)	
Malfunction Indicator Lamp (MIL).....	P. 142
ABS (Anti-lock Brake System) Indicator	P. 143
Torque Control Indicator.....	P. 144
Other Warning Indications	P. 145
Fuel Gauge Failure Indication.....	P. 145
Tyre Puncture	P. 146
Smartphone Pairing Trouble.....	P. 147

Electrical Trouble.....	P. 149
Battery Goes Dead.....	P. 149
Burned-out Light Bulb	P. 149
Blown Fuse.....	P. 150

Engine Will Not Start (HISS indicator stays on)

Starter Motor Operates But Engine Does Not Start

Check the following items:







- Check the correct engine starting sequence.  P. 89
- Check that there is petrol in the fuel tank.
- Check if the PGM-FI malfunction indicator lamp (MIL) is on.
 - ▶ If the indicator lamp is on, contact your dealer as soon as possible.
- Check if the HISS indicator stays on.
 - ▶ Turn the ignition switch to the  (Off) position and remove the key. Reinsert the key and turn the ignition switch to the  (On) position. If the indicator still stays on, check the following: Check if there is no another HISS key (including spare key) close to the ignition switch.

Check if there are no any metallic seals or stickers on the key.

If the HISS indicator still stays on, have your vehicle inspected by your dealer.

Starter Motor Does Not Operate

Check the following items:

- Check the correct engine starting sequence.  P. 89
- Make sure engine stop switch is in the  (Run) position.  P. 72
- Check for a blown fuse.  P. 150
- Check for a loose battery connection ( P. 117) or battery terminal corrosion ( P. 106).
- Check the condition of the battery.  P. 149

If the problem continues, have your vehicle inspected by your dealer.

Overheating (High coolant temperature indicator is on)

The engine is overheating when the following occurs:

- High coolant temperature indicator comes on.
- Acceleration becomes sluggish.
If this occurs, pull safely to the side of the road and perform the following procedure.

Extended fast idling may cause the high coolant temperature indicator to come on.

NOTICE

Continuing to ride with an overheated engine can cause serious damage to the engine.

1. Stop the engine using the ignition switch, and then turn the ignition switch to the **I** (On) position.

2. Check that the radiator fan is operating, and then turn the ignition switch to the **O** (Off) position.

If the fan is not operating:

Suspect a fault. Do not start the engine. Transport your vehicle to your dealer.

If the fan is operating:

Allow the engine to cool with the ignition switch in the **O** (Off) position.

3. After the engine has cooled, inspect the radiator hose and check if there is a leak.

➡ P. 122

If there is a leak:

Do not start the engine. Transport your vehicle to your dealer.

4. Check the coolant level in the reserve tank. ➡ P. 122
▶ Add coolant as necessary.
5. If 1-4 check normal, you may continue riding, but closely monitor the temperature gauge.



Warning Indicators On or Flashing

Low Oil Pressure Indicator

If the low oil pressure indicator comes on, pull safely to the side of the road and stop the engine.

NOTICE

Continuing to ride with low oil pressure can cause serious damage to the engine.

1. Check the engine oil level, and add oil as necessary.  P. 120,  P. 121
2. Start the engine.
 - ▶ Only continue riding if the low oil pressure indicator goes off.

Rapid acceleration may momentarily cause the low oil pressure indicator to come on, especially if the oil is at or near the low level. If the low oil pressure indicator stays on when the oil level is at the proper level, stop the engine and contact your dealer.

If the engine oil level goes down rapidly, your vehicle may have a leak or another serious problem. Have your vehicle inspected by your dealer.

Warning Indicators On or Flashing ► PGM-FI (Programmed Fuel Injection) Malfunction Indicator Lamp (MIL)

PGM-FI (Programmed Fuel Injection) Malfunction Indicator Lamp (MIL)

Reasons for the indicator lamp to come on or blink

- Comes on if there is a problem with the engine emissions control system.
- Blinks when engine misfiring is detected.

Troubleshooting

What to do when the indicator lamp comes on

Avoid high speeds and immediately get your vehicle inspected at a dealer.

NOTICE

If you drive with the malfunction indicator lamp on, the emissions control system and the engine could be damaged.

What to do when the indicator lamp blinks

Park the vehicle in a safe place with no flammable items and wait at least 10 minutes with the engine stopped until it cools.

NOTICE

If the malfunction indicator lamp blinks again when restarting the engine, drive to the nearest dealer at 50 km/h (31 mph) or less. Have your vehicle inspected.

Warning Indicators On or Flashing ► ABS (Anti-lock Brake System) Indicator

ABS (Anti-lock Brake System) Indicator

If the indicator operates in one of the following ways, you may have a serious problem with the ABS. Reduce your speed and have your vehicle inspected by your dealer as soon as possible.

- Indicator comes on or starts flashing while riding.
- Indicator does not come on when the ignition switch is in the **I** (On) position.
- Indicator does not go off at speeds above 10 km/h (6 mph).

If the ABS indicator stays on, your brakes will continue to work as a conventional system, but without the anti-locking function.

The ABS indicator may flash if you turn the rear wheel while the rear wheel is lifted off the ground. In this case, turn the ignition switch to the **O** (Off) position, and then to the **I** (On) position again. The ABS indicator will go off after your speed reaches 30 km/h (19 mph).

Warning Indicators On or Flashing ► Torque Control Indicator

Torque Control Indicator

If the indicator operates in one of the following ways, you may have a serious problem with the Torque Control. Reduce your speed and have your vehicle inspected by your dealer as soon as possible.

- Indicator comes and stays on (solid) while riding.
- Indicator does not come on when the ignition switch is turned to the **I** (On) position.
- Indicator does not go off at speeds above 5 km/h (3 mph).

Troubleshooting

Even when the Torque Control indicator is on, your vehicle will have normal riding ability without Torque Control function.

- When the indicator comes on while the Torque Control is in operation, you will have to completely close the throttle to regain normal riding ability.

The Torque Control indicator may come on if you rotate the rear wheel while your vehicle is lifted off the ground. In this case, turn the ignition switch to the **O** (Off) position, and then to the **I** (On) position again. The Torque Control indicator will go off after your speed reaches 5 km/h (3 mph).

Other Warning Indications

Fuel Gauge Failure Indication

If the fuel system has an error, the fuel gauge indicators will be displayed as shown in the illustrations.

If these occur, see your dealer as soon as possible.

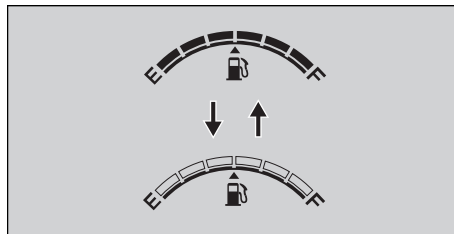
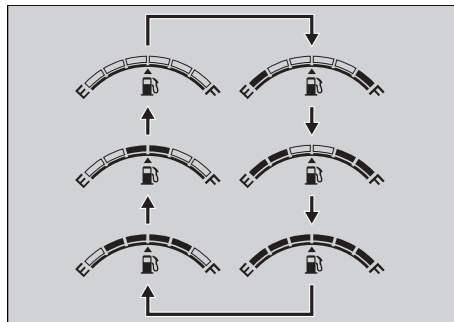
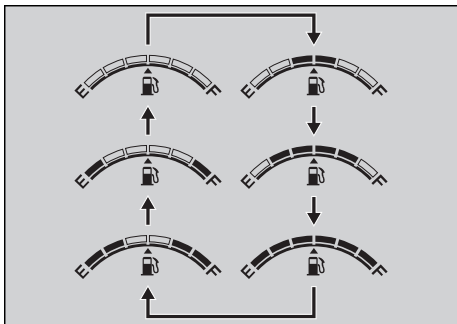

Tyre Puncture

Repairing a puncture or removing a wheel requires special tools and technical expertise. We recommend you have this type of service performed by your dealer.

After an emergency repair, always have the tyre inspected/replaced by your dealer.

Tube Repair and Replacement

If a tube is punctured or damaged, you should replace it as soon as possible. A tube that is repaired may not have the same reliability as a new one, and it may fail while you are riding.

If you need to make a temporary repair by patching a tube or using an aerosol sealant, ride cautiously at reduced speed and have the tube replaced before you ride again.

Anytime a tube is replaced, the tyre should be carefully inspected as described.

WARNING

Riding your vehicle with a temporary tyre or tube repair can be risky. If the temporary repair fails, you can crash and be seriously injured or killed.

If you must ride with a temporary tyre or tube repair, ride slowly and carefully and do not exceed 50 km/h (30 mph) until the tyre or tube is replaced.

Smartphone Pairing Trouble

Symptom	Cause/remedy
Unable to pair a smartphone	Some smartphones you use may be incompatible with the vehicle and/or the operable functions may be limited.
	Check that the vehicle and smartphone are both in pairing mode. ➤ P. 82
	Check your surroundings to make sure no other device being paired is present before re-pairing. Presence of a <i>Bluetooth</i> ® device in the vicinity sometimes affects the pairing due to radio wave interference, etc.
	When connecting a smartphone, make sure no other <i>Bluetooth</i> ® device readied for pairing is present. Presence of a <i>Bluetooth</i> ® device in the vicinity sometimes affects the pairing due to radio wave interference, etc.
	Check that the vehicle pairing information is deleted from your smartphone <i>Bluetooth</i> ® setting. Depending on the smartphone used, connecting may not be possible unless the pairing information is deleted.

Smartphone Pairing Trouble

Symptom	Cause/remedy
<p data-bbox="182 436 393 493">Unable to connect a smartphone</p>	<p data-bbox="471 246 1143 342">Depending on the smartphone you use, it may take some time for the vehicle to connect to a smartphone and to start using a dedicated application.</p> <p data-bbox="471 350 1143 443">The connection may be temporarily disconnected when starting the engine, which is normal and not a malfunction. The smartphone will be reconnected after the engine is started.</p> <p data-bbox="471 450 1143 547">Check that <i>Bluetooth</i>[®] status icon comes on. Refer to the instruction manual of your smartphone and check that your smartphone is in connectable state.</p> <p data-bbox="471 554 1143 650">Some smartphones you use may not connect automatically. For connecting, follow the instructions in the instruction manual of your smartphone.</p> <p data-bbox="471 657 1143 691">You cannot connect two or more smartphones at once.</p>

If the problem continues after the above-described inspection, have your vehicle inspected by your dealer.

Electrical Trouble

Battery Goes Dead

Charge the battery using a motorcycle battery charger.

Remove the battery from the vehicle before charging.

Do not use an automobile-type battery charger, as these can overheat a motorcycle battery and cause permanent damage. If the battery does not recover after recharging, contact your dealer.

NOTICE

Jump starting using an automobile battery can damage your vehicle's electrical system and is not recommended.

Burned-out Light Bulb

All light bulbs on the vehicle are LEDs. If there is an LED which is not turned on, see your dealer for servicing.

Electrical Trouble ► Blown Fuse

Blown Fuse

Before handling fuses, see “Inspecting and Replacing Fuses.” ► P. 108

■ Fuse Box Fuses

1. Remove the seat. ► P. 119
2. Remove the fuse box cover.
3. Pull the fuses out one by one with the fuse puller in the tool kit and check for a blown fuse. Always replace a blown fuse with a spare fuse of the same rating.
4. Reinstall the fuse box cover.
5. Reinstall the seat.

Troubleshooting

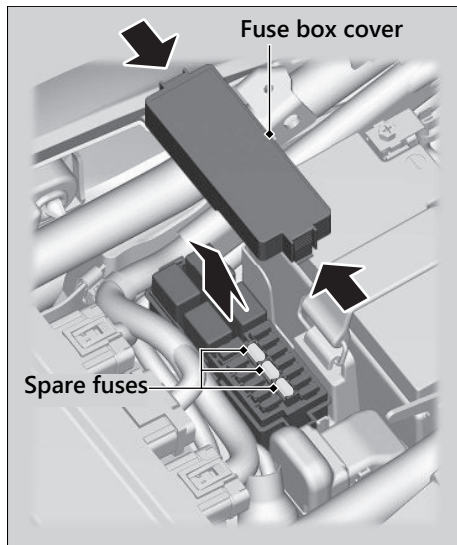

Electrical Trouble ► Blown Fuse

I Main Fuse

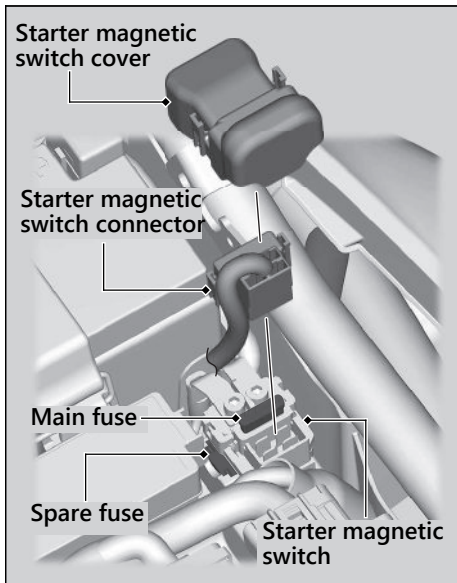

1. Remove the seat. ► P. 119
2. Disconnect the negative \ominus terminal from the battery. ► P. 117
3. Remove the starter magnetic switch cover.
4. Remove the starter magnetic switch connector.
5. Pull the main fuse out and check for a blown fuse. Always replace a blown fuse with a spare fuse of the same rating.
6. Reinstall parts in the reverse order of removal.

NOTICE

If a fuse fails repeatedly, you likely have an electrical problem. Have your vehicle inspected by your dealer.

Information

Service Diagnostic Recorders.....	P. 153
Keys.....	P. 154
Instruments, Controls, & Other Features...	P. 155
Caring for Your Vehicle.....	P. 159
Storing Your Vehicle.....	P. 163
Transporting Your Vehicle	P. 163
You & the Environment	P. 164
Serial Numbers	P. 165
Fuels Containing Alcohol	P. 166
Catalytic Converter	P. 167

Service Diagnostic Recorders

Service Diagnostic Recorders

Your vehicle is equipped with service-related devices that record information about powertrain performance and riding conditions. The data can be used to help technicians diagnose, repair and maintain the vehicle. This data may not be accessed by anyone else except as legally required or with the permission of the vehicle owner.

However this data may be accessed by Honda, its authorised dealers and authorised repairers, employees, representatives and contractors only for the purpose of the technical diagnosis, research and development of the vehicle.

Information

Keys

Keys

Ignition Key

This vehicle has two ignition keys and a key tag with a key number and a bar code.

The ignition key contains a special coded chip that is recognized by the immobilizer system (HIS) in order to start the engine. Handle the key carefully to prevent damaging the HIS components.

- Do not bend keys or subject them to undue stress.
- Avoid prolonged exposure to sunlight or high temperatures.
- Do not grind, drill or in any way alter their shape.
- Do not expose to strong magnetic objects.

If you lose all ignition keys and the key tag, the PGM-FI unit/ignition control module must be replaced by your dealer. To avoid this, keep a duplicate key.

If you lose a key, make another duplicate key immediately.

To make a duplicate key and register it with your HIS system, take the spare key, the key tag, and the vehicle to your dealer.

- ▶ Store the key tag in a safe location.

A metal key holder may cause damage to the area surrounding the ignition switch.

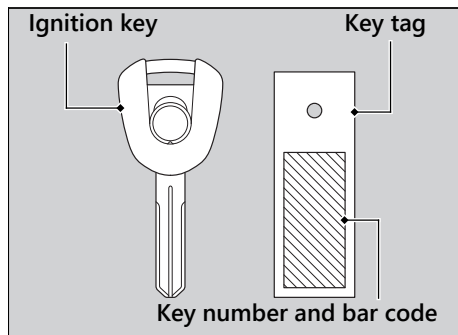

Instruments, Controls, & Other Features

Ignition Switch

Leaving the ignition switch in the **I** (On) position with the engine stopped will drain the battery. Do not turn the key while riding.

Engine Stop Switch

Do not use the engine stop switch except in an emergency. Doing so when riding will cause the engine to suddenly turn off, making riding unsafe.

If you stop the engine using the engine stop switch, turn the ignition switch to the **O** (Off) position. Failing to do so will drain the battery.

Instruments, Controls, & Other Features

Odometer

The display remains at 999,999 when the odometer exceeds 999,999.

Tripmeter

Each tripmeter resets to 0.0 when the trip mileage exceeds 9,999.9.

HISS

The Honda Ignition Security System (HISS) immobilizes the engine's ignition system if an improperly-coded key is used to try and start the engine. When the ignition switch is turned to the **O** (Off) position, the HISS immobilizer system is always alert, even if the HISS indicator is not flashing.

If the ignition switch is turned to the **I** (On) position with the engine stop switch in the **O** (Run) position, the HISS indicator turns on and goes off after a few seconds to indicate it is OK to start the engine. **HISS Indicator Does Not Turn off**  P. 139

Instruments, Controls, & Other Features

The HISS indicator starts flashing every 2 seconds for 24 hours after the ignition switch is turned to the **O** (Off) position. You can turn this feature on or off. **P. 52**

EU Directive

This immobilizer system complies with the RE (Radio Equipment) Directive (2014/53/EU).



The declaration of conformity to RE Directive is provided to the owner at the time of purchase. The declaration of conformity should be kept at a safe place. When the declaration of conformity is lost or is not provided, contact your dealer.

South Africa only



Document Bag

The owner's manual, registration, and insurance information can be stored in the plastic document bag located underside of the seat. **P. 119**

Ignition Cut-off System

A banking (lean angle) sensor automatically stops the engine and fuel pump if the vehicle falls over. To reset the sensor, you must turn the ignition switch to the **O** (Off) position and back to the **I** (On) position before the engine can be restarted.

Instruments, Controls, & Other Features

Throttle by Wire System

This model is equipped with a Throttle by Wire System.

Do not put magnetized items or items susceptible to magnetic interference near the right handlebar switches.

Automatic Brightness Control

The meter backlight brightness and background colour will be automatically controlled if "AUTO" is selected on the BRIGHTNESS and BACKGROUND settings. ➤ P. 53 ➤ P. 54 Ambient brightness is detected by the photosensor.

Do not damage or cover the photosensor. Otherwise, the automatic brightness control may not work properly.

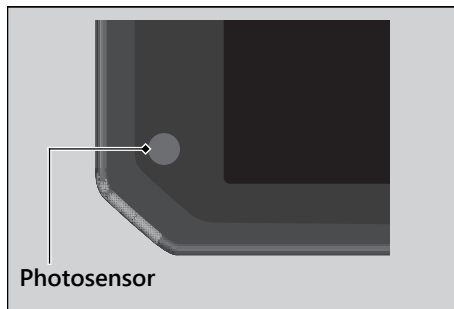

Information

Instruments, Controls, & Other Features

Honda Smartphone Voice Control system

Singapore only

Complies with
IMDA Standards
DA105282

Serbia only



Russia only



Argentina only

R! RAMATEL

C-27664

Information

Caring for Your Vehicle

Caring for Your Vehicle

Frequent cleaning and polishing is important to ensure the life of your Honda. A clean vehicle makes it easier to spot potential problems. In particular, seawater and salts used to prevent ice on roads promote the formation of corrosion. Always wash your vehicle thoroughly after riding on coastal or treated roads.

Washing

Allow the engine, muffler, brakes, and other high-temperature parts to cool before washing.

1. Rinse your vehicle thoroughly using a low pressure garden hose to remove loose dirt.
2. If necessary, use a sponge or a soft towel with mild cleaner to remove road grime.
 - ▶ Clean the headlight lens, panels, wind screen, and other plastic components with extra care to avoid scratching them. Avoid directing water into the air cleaner, muffler, and electrical parts.

3. Thoroughly rinse your vehicle with plenty of clean water and dry with a soft, clean cloth.
4. After the vehicle dries, lubricate any moving parts.
 - ▶ Make sure that no lubricant spills onto the brakes or tyres. Brake discs, pads, drum or shoes contaminated with oil will suffer greatly reduced braking effectiveness and can lead to a crash.
5. Lubricate the drive chain immediately after washing and drying the vehicle.
6. Apply a coat of wax to prevent corrosion.
 - ▶ Avoid products that contain harsh detergents or chemical solvents. These can damage the metal, paint, and plastic on your vehicle. Keep the wax clear of the tyres and brakes.
 - ▶ If your vehicle has any mat painted parts, do not apply a coat of wax to the mat painted surface.

Caring for Your Vehicle

■ Washing Precautions

Follow these guidelines when washing:

- Do not use high-pressure washers:
 - ▶ High-pressure water cleaners can damage moving parts and electrical parts, rendering them inoperable.
 - ▶ Water in the air intake can be drawn into the throttle body and/or enter the air cleaner.
- Do not direct water at the muffler:
 - ▶ Water in the muffler can prevent starting and causes rust in the muffler.
- Dry the brakes:
 - ▶ Water adversely affects braking effectiveness. After washing, apply the brakes intermittently at low speed to help dry them.
- Do not direct water under the seat:
 - ▶ Water in the under seat compartment can damage your documents and other belongings.

- Do not direct water at the air cleaner:
 - ▶ Water in the air cleaner can prevent the engine from starting.
- Do not direct water near the headlight:
 - ▶ The headlight's inside lens may fog temporarily after washing or while riding in the rain. This does not impact the headlight function.
However, if you see a large amount of water or ice accumulated inside the lens(es), have your vehicle inspected by your dealer.
- Do not use wax or polishing compounds on matte painted surfaces:
 - ▶ Use a soft cloth or sponge, plenty of water, and a mild detergent to clean matte painted surfaces. Dry with a soft clean cloth.

Caring for Your Vehicle

Aluminium Components

Aluminium will corrode from contact with dirt, mud, or road salt. Clean aluminium parts regularly and follow these guidelines to avoid scratches:

- Do not use stiff brushes, steel wool, or cleaners containing abrasives.
- Avoid riding over or scraping against curbs.

Panels

Follow these guidelines to prevent scratches and blemishes:

- Wash gently using a soft sponge and plenty of water.
- To remove stubborn stains, use diluted detergent and rinse thoroughly with plenty of water.
- Avoid getting petrol, brake fluid, or detergents on the instruments, panels, or headlight.

Windscreen

Using plenty of water, clean the windscreen with a soft cloth or sponge. (Avoid using detergents or any kind of chemical cleaner on the windscreen.) Dry with a soft, clean cloth.

NOTICE

To avoid possible scratching or other damage, use only water and a soft cloth or sponge to clean the windscreen.

For a dirtier windscreen, use a diluted neutral detergent with a sponge and plenty of water. Make sure to wash off all the detergent. (Detergent residue may cause windscreen cracks.)

Replace the windscreen if scratches cannot be removed and they obstruct clear vision. Take care to keep battery electrolyte, brake fluid, or other chemical solvents off the windscreen and screen garnish. They will damage the plastic.

Caring for Your Vehicle

Exhaust Pipe and Muffler

The exhaust pipe and muffler are stainless steel but may become stained by mud or dust.

To remove mud or dust, use a wet sponge and a liquid kitchen abrasive, then rinse well with clean water. Dry with chamois or a soft towel.

If necessary, remove heat stains by using a commercially available fine texture compound. Then, rinse by the same manner as removing mud or dust.

Information

If the exhaust pipe and muffler are painted, do not use a commercially available abrasive kitchen cleaning compound. Use a neutral detergent to clean the painted surface on the exhaust pipe and muffler. If you are not sure if your exhaust pipe and muffler are painted, contact your dealer.



NOTICE

Even though the exhaust is made of stainless steel, it can become stained. Remove all marks and blemishes as soon as they are noticed.

Storing Your Vehicle

If you store your vehicle outdoors, you should consider using a full-body cover.

If you won't be riding for an extended period, follow these guidelines:

- Wash your vehicle and wax all painted surfaces (except mat painted surfaces). Coat chrome pieces with rust-inhibiting oil.
- Lubricate the drive chain.  P. 110
- Place your vehicle on a maintenance stand and position a block so that both tyres are off the ground.
- After rain, remove the body cover and allow the vehicle to dry.
- Remove the battery ( P. 117) to prevent discharge. Fully charge the battery and then place it in a shaded, well-ventilated area.
 - ▶ If you leave the battery in place, disconnect the negative \ominus terminal to prevent discharge.

After removing your vehicle from storage, inspect all maintenance items required by the Maintenance Schedule.

Transporting Your Vehicle

If your vehicle needs to be transported, it should be carried on a motorcycle trailer or a flatbed truck or trailer that has a loading ramp or lifting platform and motorcycle tie-down straps. Never try to tow your vehicle with a wheel or wheels on the ground.

NOTICE

Towing your vehicle with a wheel or wheels on the ground can cause serious damage to the transmission.

You & the Environment

You & the Environment

Owning and riding a vehicle can be enjoyable, but you must do your part to protect the environment.

Choose Sensible Cleaners

Use a biodegradable detergent when you wash your vehicle. Avoid aerosol spray cleaners that contain chlorofluorocarbons (CFCs) which damage the atmosphere's protective ozone layer.

Information

Recycle Wastes

Put oil and other toxic wastes in approved containers and take them to a recycling centre. Call your local or state office of public works or environmental services to find a recycling centre in your area and to get instructions on how to dispose of non-recyclable wastes. Do not place used engine oil in the trash or pour it down a drain or on the ground. Used oil, petrol, coolant, and cleaning solvents contain poisons that can hurt refuse workers and contaminate drinking water, lakes, rivers, and oceans.

Serial Numbers

Serial Numbers

The frame and engine serial numbers uniquely identify your vehicle and are required in order to register your vehicle. They may also be required when ordering replacement parts. You should record these numbers and keep them in a safe place.

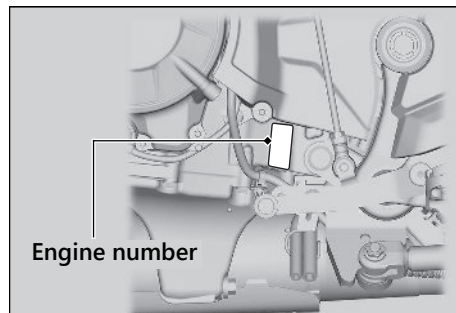
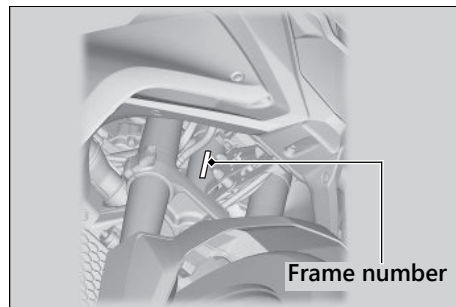

Information

Fuels Containing Alcohol

Fuels Containing Alcohol

Some conventional fuels blended with alcohol are available in some locales to help reduce emissions to meet clean air standards. If you plan to use blended fuel, check that it is unleaded and meets the minimum octane rating requirement.

The following fuel blends can be used in your vehicle:

- Ethanol (ethyl alcohol) up to 10% by volume.
 - ▶ Petrol containing ethanol may be marketed under the name Gasohol.

The use of petrol containing more than 10% ethanol may:

- Damage the painting of the fuel tank.
- Damage the rubber tubes of the fuel line.
- Cause corrosion of the fuel tank.
- Cause poor drivability.

NOTICE

Use of blended fuels containing higher than approved percentages can damage metal, rubber, plastic parts of your fuel system.

If you notice any undesirable operating symptoms or performance problems, try a different brand of petrol.

Catalytic Converter

Catalytic Converter

This vehicle is equipped with a three-way catalytic converter. The catalytic converter contains precious metals that serve as catalysts in high temperature chemical reactions that convert hydrocarbons (HC), carbon monoxide (CO), and oxides of nitrogen (NOx) in the exhaust gases into safe compounds.

A defective catalytic converter contributes to air pollution and can impair your engine's performance. A replacement unit must be an original Honda part or equivalent.

Follow these guidelines to protect your vehicle's catalytic converter:

- Always use unleaded petrol. Leaded petrol will damage the catalytic converter.
- Keep the engine in good running condition.
- Have your vehicle serviced if your engine is misfiring, backfiring, stalling, or otherwise not running properly, stop riding and turn off the engine.

Specifications

■ Main Components

Overall length	2,325 mm (91.5 in)
Overall width	838 mm (33.0 in)
Overall height	1,450 mm (57.1 in)
Wheelbase	1,560 mm (61.4 in)
Minimum ground clearance	210 mm (8.3 in)
Caster angle	27° 0'
Trail	111 mm (4.4 in)
Curb weight	208 kg (459 lb)
Maximum weight capacity *1	207 kg (456 lb)
Maximum luggage weight *2	19.5 kg (43 lb)
Passenger capacity	Rider and 1 passenger
Minimum turning radius	2.61 m (8.6 ft)
Displacement	755 cm ³ (46.1 cu-in)
Bore x stroke	87.0 x 63.5 mm (3.43 x 2.50 in)
Compression ratio	11.0:1
Fuel	Unleaded petrol 91 RON or higher
Fuel containing alcohol	ETHANOL up to 10 % by volume
Tank capacity	16.9 L (4.46 US gal, 3.72 Imp gal)

Specifications

Battery	YZT10S
	12 V-8.6 Ah (10 HR)/12 V-9.1 Ah (20 HR)
Gear ratio	1st 3.000
	2nd 2.187
	3rd 1.650
	4th 1.320
	5th 1.096
	6th 0.939
Reduction ratio (primary / final)	1.777 / 2.812

*1 : Including rider, passenger, all luggages, and accessories

*2 : Includes the weight of the luggage and added accessories.

Specifications

■ Service Data

Tyre size	Front	90/90-21 M/C 54H
	Rear	150/70R18 M/C 70H
Tyre type	Front	bias-ply, tube
	Rear	radial, tube
Recommended Tyre	Front	METZELER KAROO STREET
		DUNLOP MIXTOUR A
	Rear	METZELER KAROO STREET
		DUNLOP MIXTOUR A
Tyre category of use *1	Normal	Permitted
	Special	Not Permitted
	Snow	Not Permitted
	Moped	Not Permitted
Tyre air pressure (Driver only)	Front	225 kPa (2.25 kgf/cm ² , 33 psi)
	Rear	250 kPa (2.50 kgf/cm ² , 36 psi)
Tyre air pressure (Driver and passenger)	Front	225 kPa (2.25 kgf/cm ² , 33 psi)
	Rear	280 kPa (2.80 kgf/cm ² , 41 psi)
Minimum tread depth	Front	3.0 mm (0.12 in)
	Rear	3.0 mm (0.12 in)
Spark plug (standard)	SILMAR8A9S (NGK)	
Spark plug gap	0.8 - 0.9 mm (0.03 - 0.04 in)	
Idle speed	1,300 ± 100 rpm	

*1: EU regulation

Recommended engine oil	Honda 4-stroke motorcycle oil API Service Classification SJ or higher, excluding oils marked as "Energy Conserving" or "Resource Conserving," SAE 10W-30, JASO T 903 standard MA	
	After draining	3.4 L (3.6 US qt, 3.0 Imp qt)
Engine oil capacity	After draining & engine oil filter change	3.6 L (3.8 US qt, 3.2 Imp qt)
	After disassembly	3.9 L (4.1 US qt, 3.4 Imp qt)
Recommended brake fluid	Honda DOT 4 Brake Fluid	
Cooling system capacity	1.53 L (1.62 US qt, 1.35 Imp qt)	
Recommended coolant	Except India and Singapore	Pro Honda HP Coolant
	India and Singapore	HONDA PRE-MIX COOLANT
Recommended drive chain lubricant	Drive chain lubricant designed specifically for O-ring chains	
	If not available, use SAE 80 or 90 gear oil.	
Drive chain slack	50 - 55 mm (2.0 - 2.2 in)	
Standard drive chain	DID520VM5 or RK520KZOZ2	
	No. of links	126
Standard sprocket size	Drive sprocket	16T
	Driven sprocket	45T

Specifications

■ Bulb

Headlight	LED
Brakelight/Taillight	LED
Front turn signal/Position light	LED
Rear turn signal	LED
License plate light	LED

■ Fuse

Main fuse	30 A
Other fuse	30 A, 15 A, 10 A